

RMP60 radio transmission probe

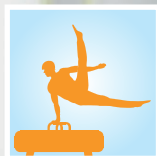

Flexible
probing solution

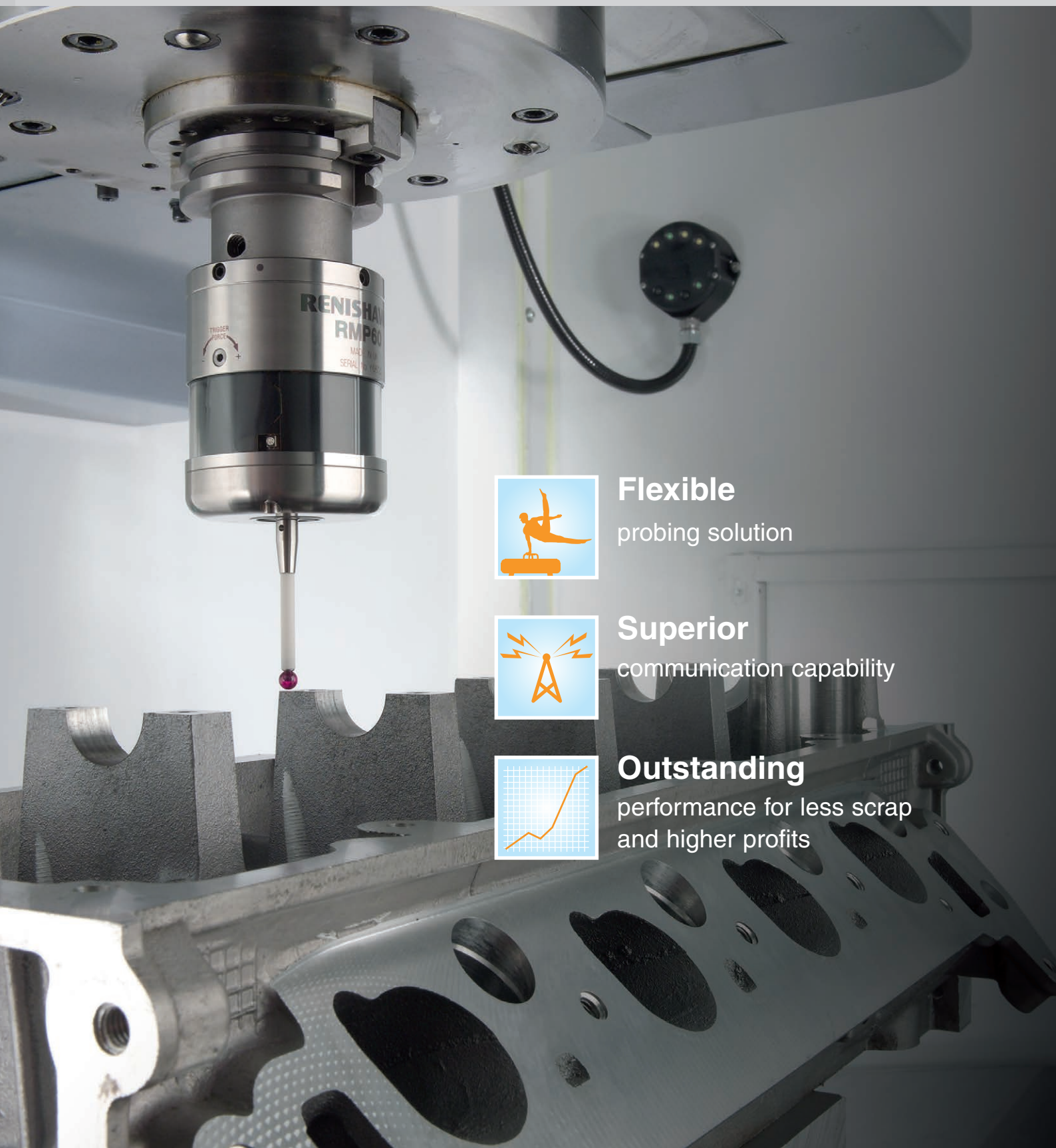
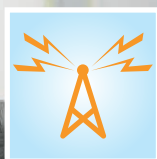

Superior
communication capability

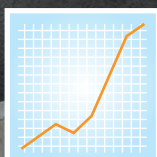

Outstanding
performance for less scrap
and higher profits

RMP60 – innovative process control

Tackle process variation at source, and reap the rewards

The higher the degree of human involvement in the manufacturing process, the higher the risk for error. Automated in-process measurement using Renishaw probes can help **eliminate the risk**. The Renishaw RMP60 radio probe system can facilitate the following measures for enhanced management of your production leading to an **increase in your profits**.

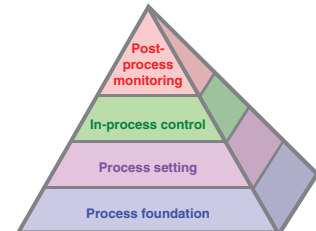

Process setting

Automated on-machine measurement of component position and alignment.

- Eliminate costly fixtures and manual setting errors
- Introduce new processes quickly and respond to new customer needs
- Set up faster, improve quality and reduce scrap

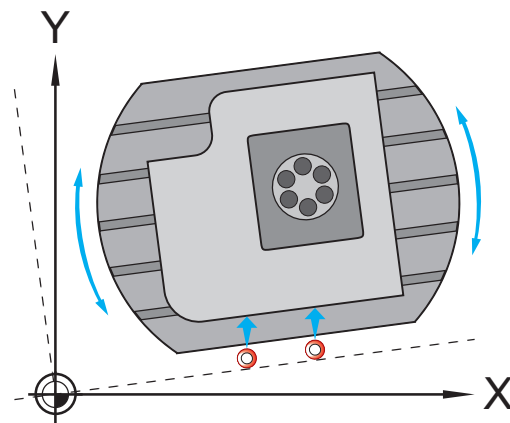

In-process control

Automated measurement of roughed and finished multi-axis features.

- Improve process capability and traceability
- Compensate for environmental and machine conditions
- Reduce non-productive time and scrap
- Increase productivity and profits

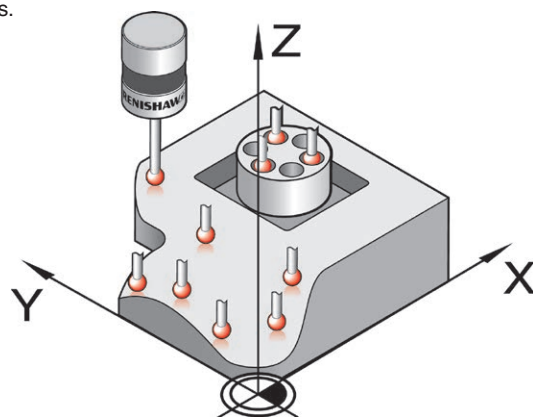

Probing pays...

Machine tools that are optimised to cut more metal, more reliably and more accurately will quickly **maximise productivity, profits and your competitive edge.**



Automated part setting with the Renishaw RMP60 probe is up to 10 times faster than manual methods, which means immediate and **significant cost savings.**

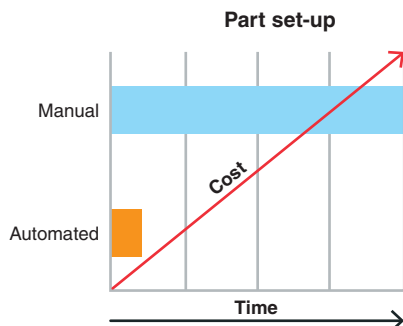

Scrap and rework reduce productivity and profits. The Renishaw RMP60 probe helps guarantee "right first time" parts which means **reduced waste and increased profits.**

RMP60 key features

- Compact design with radio transmission for medium to large machining centres and mill-turn centres
- Kinematic design - proven and patented
- Trigger Logic™ for quick and easy set up
- Delivers interference free transmission through the use of frequency hopping spread spectrum (FHSS)
- Globally recognised 2.4 GHz waveband - compliant with radio regulations in all major markets

... the Renishaw way

Renishaw, an established world leader in metrology solutions invented the touch-trigger probe in the 1970s.

Decades of customer focus and investment in development, coupled with our own manufacturing experience enables us to provide **innovative** and **exceptional products** that are unmatched for technical excellence and performance.

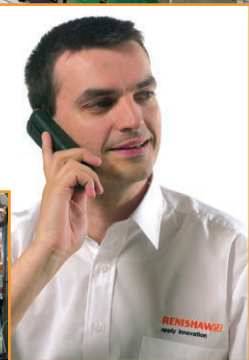

Customer comment

"During the planning stage of the project it occurred to us that the new machine would be located close to the welding area and that there was a very real possibility of signal interference, so we needed a system that could cope with the conditions. The Renishaw RMP60 is the first inspection probe to use frequency hopping spread spectrum (FHSS) data transmission."

Paul Hinchliffe, Asquith-Butler

RMP60 – compact, robust and proven technology

The world's first touch-trigger probe was based on a kinematic resistive principle. Today the basis of this proven design continues to play an invaluable role in part set-up, measurement and process control. This has firmly established Renishaw as a world leader in the design, manufacture and support of dimensional measurement products.

Renishaw is trusted and its products chosen by the world's leading machine builders and the majority of end-users.



The world's first touch-trigger probe

Principle of operation

Three equally spaced rods rest on six tungsten carbide balls to provide six points of contact.

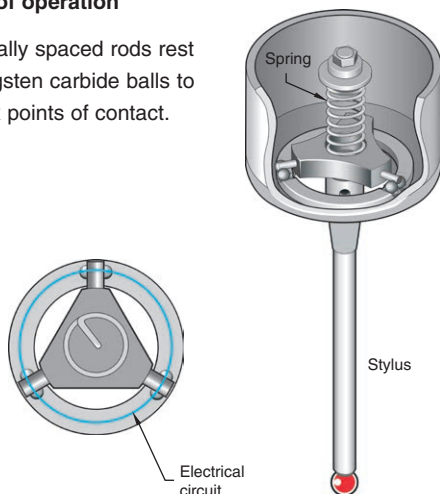

Under load of the spring, contact patches are created between the balls and the rods through which the electrical current flows. Upon making contact with (touching) a work-piece, the force translated through the stylus moves the balls and rods apart thus reducing the size of the contact patches and increasing their electrical resistance.

When a defined threshold is reached the probe is triggered.

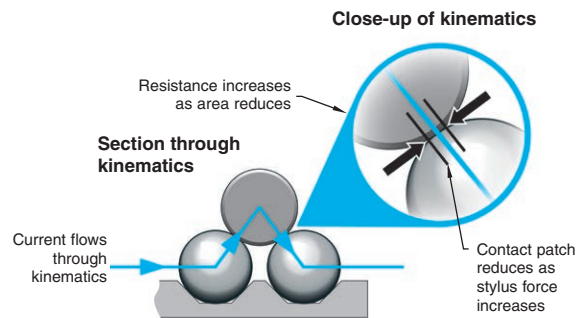

Repeatable electrical triggering and mechanical reseating of the mechanism are critical to this process and fundamental to reliable metrology.

A multitude of applications

Suitable for all machining and mill-turn centres, the RMP60 features an integrated probe module for exceptional robustness and generous over-travel. Its radio capability combined with compact design enables users to:

- Benefit from probing in a multi-spindle environment where line of sight between probe and interface is not guaranteed
- Access previously difficult to reach workpiece areas such as small recesses and awkward features
- Easily retrofit to existing machines

Advantages

- Proven Renishaw technology
- Robust in the harshest environment
- Reliable measurement
- Long service life
- Fast to install
- Easy to use

Key benefits

- Reduced set-up and calibration time
- More time for machining
- Improved process control and quality
- Reduced rework, concessions and scrap
- Increased automation and reduced operator intervention
- Increased payback and profits
- Greater competitive edge and business opportunity

RMP60 and RMI-Q optimised for reliable and safe operation

The benefits of FHSS

In addition to its high performance optical systems Renishaw offers a reliable radio solution for larger machines and/or installations where line-of-sight applications are not possible.

Frequency hopping spread spectrum (FHSS) is a robust and proven technology, that enables devices to jump from channel to channel.

Unlike other protocols which may require manual intervention, Renishaw's products will continue to work as other devices such as Wi-Fi, Bluetooth and microwave enter the same environment.

Operating within the recognised 2.4 GHz frequency band, RMI-Q is compliant with radio regulations in all major markets. It is the preferred choice of many leading machine builders and experienced users.



Ease of use and reliability

Unique to Renishaw, Trigger Logic™ is a simple method enabling the user to quickly adjust probe mode settings for specific applications.

Constructed from the highest grade materials, Renishaw probes are robust and reliable in the harshest environments including shock, vibration, temperature extremes and even continual liquid immersion.

Also available as RMP60M, a modular system combining adaptors, extensions and Renishaw's LP2 touch probe to solve difficult application and restricted space problems.



Engineered for superior performance

Through the optimisation of transmission and power, RMI-Q partnered with Renishaw's radio transmission probes provides high operational integrity, long battery life and the superior capabilities required in demanding machine shop environments.

- Multiple Renishaw radio probes will reliably co-exist in machine shops of any size
- Combine up to four RMP60* and/or RTS (Radio tool setters) with a single RMI-Q
- Negligible interference from other radio sources ensures consistent and reliable performance
- Does not require a carefully managed radio/wireless environment
- Renishaw probes work with widely available "off-the-shelf" batteries

* Latest generation RMP60 only easily identified by a 'Q' symbol on the probe body.

About Renishaw

Renishaw is an established world leader in engineering technologies, with a strong history of innovation in product development and manufacturing. Since its formation in 1973, the company has supplied leading-edge products that increase process productivity, improve product quality and deliver cost-effective automation solutions.

A worldwide network of subsidiary companies and distributors provides exceptional service and support for its customers.

Products include:

- Additive manufacturing and vacuum casting technologies for design, prototyping, and production applications
- Dental CAD/CAM scanning systems and supply of dental structures
- Encoder systems for high accuracy linear, angle and rotary position feedback
- Fixturing for CMMs (co-ordinate measuring machines) and gauging systems
- Gauging systems for comparative measurement of machined parts
- High speed laser measurement and surveying systems for use in extreme environments
- Laser and ballbar systems for performance measurement and calibration of machines
- Medical devices for neurosurgical applications
- Probe systems and software for job set-up, tool setting and inspection on CNC machine tools
- Raman spectroscopy systems for non-destructive material analysis
- Sensor systems and software for measurement on CMMs
- Styli for CMM and machine tool probe applications

For worldwide contact details, visit www.renishaw.com/contact



RENISHAW HAS MADE CONSIDERABLE EFFORTS TO ENSURE THE CONTENT OF THIS DOCUMENT IS CORRECT AT THE DATE OF PUBLICATION BUT MAKES NO WARRANTIES OR REPRESENTATIONS REGARDING THE CONTENT. RENISHAW EXCLUDES LIABILITY, HOWSOEVER ARISING, FOR ANY INACCURACIES IN THIS DOCUMENT.

©2015 Renishaw plc. All rights reserved.

Renishaw reserves the right to change specifications without notice.

RENISHAW and the probe symbol used in the RENISHAW logo are registered trade marks of Renishaw plc in the United Kingdom and other countries. apply innovation and names and designations of other Renishaw products and technologies are trade marks of Renishaw plc or its subsidiaries. All other brand names and product names used in this document are trade names, trade marks or registered trade marks of their respective owners.



H - 2000 - 3350 - 05 - A

Issued: 0115 Part no. H-2000-3350-05-A