

# PLASMA CUTTING



**ERMAKSAN**

INNOVATIVE TECHNOLOGIES

- Since 1965 -

[ermaksan.com.tr](http://ermaksan.com.tr)

# PLASMA CUTTING

## PLASMA CUTTING

### EPL 3 AXIS XPR

### EPL 3 AXIS HPR



#### **4** New Generation Plasma System...

- 19" LCD industrial type touch screen
- Phoenix interface
- Hypertherm Core automatic gas console
- Nozzle Sensor
- 220 mm standard stroke
- 3-axis
- ProNest® CAD/CAM software
- Pneumatic system cutting table
- Pilz safe PLC module
- 6 x mechanical stops
- Plasma marking
- ERMAK THC height control system

#### **16** High Performance Maximum Productivity

- 19" LCD industrial type touch screen
- Phoenix interface
- Metric and inch gauges
- Hypertherm Manual gas console
- Plasma marking
- Nozzle Sensor
- 220 mm standard stroke
- 3-axis
- ProNest® CAD/CAM software
- Pneumatic system cutting table
- Pilz safe PLC module
- 6 x mechanical stops
- ERMAK THC height control system

Designed to work for many years under harsh production conditions, Ermaksan plasma cutting machines are equipped with advanced technology and functionality. With both oxygen and plasma cutting heads, they offer their users a high performance and optimum cutting capability. Offering flexible solutions in accordance with customer requirements, Ermaksan designs its machines for maximum efficiency with the solutions offered for custom sizes, special cuts, and adaptation to automation based on the demands received. Equipped with the latest technologies, Ermaksan plasma cutting machines meets the expectations of the users at the highest level thanks to their high performance and productivity in many industries from machining workshops to shipyards.

Committed to producing robust and high performance machines, Ermaksan's plasma cutting machines, which are manufactured to respond the requirements, are equipped with strong components. Ermaksan plasma cutting machines shall be your closest partner in order to achieve maximum efficiency even in your most demanding cutting operations.

## EPL 5 AXIS



### Bring a New Dimension to your Cutting Operations...

**26**

- 19" LCD industrial type touch screen
- Phoenix interface
- Metric and inch gauges
- Hypertherm Manual gas console
- Ermak THC automatic height control system
- Plasma marking
- Nozzle Sensor
- 5-axis cutting head
- 400 mm standard stroke
- 3-axis
- ProNest® CAD/CAM software
- Pneumatic system cutting table
- Pilz safe PLC module
- 6 x mechanical stops

## TUBE AND PROFILE CUTTING



### Impressive Solutions for Tube Cutting...

**32**

- Hypertherm Manual gas console
- Ermak THC automatic height control system
- 400 mm standard stroke
- Chuck centering mechanism
- 3-axis
- ProNest® CAD/CAM software
- Pneumatic system cutting table
- Pilz safe PLC module
- Plasma marking
- Rotary Tube Pro CAD/CAM software
- 19" LCD industrial type touch screen
- Phoenix interface

**38**

## SMART PLASMA

**44**

## OPTIONAL EQUIPMENT

**46**

## SPECIAL PROJECTS

**50**

## SERVICE AND SPARE PARTS

# EPL PLASMA

• 3-AXIS XPR SERIES

## New Generation Plasma System...

XPR300™ represents the latest level in Hypertherm's state-of-the-art plasma cutting technology and provides great savings from operating costs. The XPR, the new generation plasma system, offers the widest range of opportunities ever. While speed and efficiency are increased significantly, operating costs are reduced by 50%.

Designed as per the new operating characteristics, the system optimization allows for easier operation by minimizing operator intervention besides the high performance. In this way, high quality cuts are obtained.

- ▶ Low energy consumption
- ▶ Low cost of operation
- ▶ Long life performance
- ▶ High efficiency
- ▶ Simple operation



### HIGH CUTTING QUALITY

By combining new technology with refined processes for new generation, X-Definition™ cutting operations on black sheet, stainless steel and aluminium materials, XPR brings the HyDefinition cutting quality much further.

### EASE OF USE

Ensures easier operation with minimum operator intervention.





### **LONG-TERM SAVINGS**

System feedback is provided thanks to the advanced power supply technology. Intervention is performed automatically to prevent events that affect efficiency of the system and the life cycle of consumables adversely.

### **LOW ENERGY CONSUMPTION**

Designed for energy efficiency and lesser use of sources. Thus, savings and efficiency of the end user are increased and effects on the environment are reduced.

# EPL PLASMA

## • 3 AXIS XPR GAS CONTROL FUNCTIONS

### Engineered System Optimization And Ease Of Use

- Superior results on aluminum using Vented Water Injection™ (VWI)
- Increases consumable life 3 times that of competitor's systems by eliminating the impact of ramp down errors
- Reduces the impact of catastrophic electrode blowouts which can damage the torch at high current levels
- Automatic system monitoring and specific troubleshooting codes for improved maintenance and service prompts
- EasyConnect™ torch lead and one hand torch-to receptacle connection for fast and easy change-outs
- QuickLock™ electrode for easy consumable replacement
- WiFi in the power supply can connect to mobile devices and LAN for multiple system monitoring and service

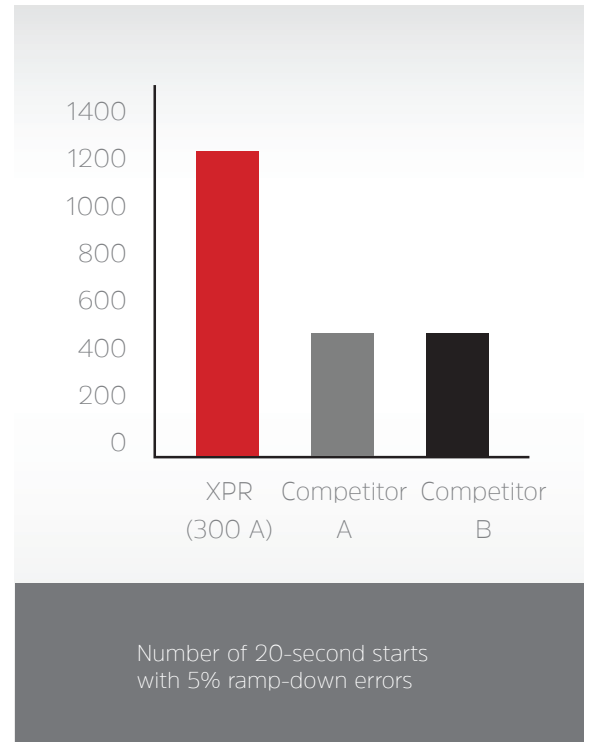

Building on Hypertherm's industry-leading productivity technologies, XPR™ delivers faster cut speeds, higher quality cuts that reduce or eliminate secondary operations and increased consumable life with quicker set up time. These combine to further slash plasma system operating costs.



■ XPR 300

		XPR300
Maximum output power		63 kW
100% duty arc voltage		210 V
Cut chart thickness		mm (inch)
Pierce capacity	Mild steel (argon-assist)	50 (2)
	Mild steel (standard O2)	45 (1-3/4)
	Stainless steel	38 (1-1/2)
Severance capacity	Aluminum	38 (1-1/2)
	Mild steel	80 (3-1/8)
	Stainless steel	75 (3)
	Aluminum	50 (2)



### Core™ Consol

Standard

Unmatched mild steel cutting performance and superior angularity and edge finish on stainless steel up to 12 mm (1/2"). This is delivered through a new N2 HDi™ process that prevents the mixing of air into the plasma gas, creating an improved, brighter edge finish.



### Vented Water Injection (VWI) Consol

Optional

All Core console capabilities plus argon marking and a more than 10% increase in piercing thickness with argon-assist. Significantly enhanced stainless steel and aluminum capabilities are delivered with the addition of F5 HDi processes and patent pending Vented Water Injection (VWI).



### OptiMix™ Consol

Optional

All the capabilities of the Core and VWI consoles plus discrete 3-gas mixing – Ar, H2, and N2 – for the world's most flexible, premium stainless steel and aluminum cutting capability.



Gas-connect console gases/fluids			
	Core	Vented Water Injection (VWI)	OptiMix
O <sub>2</sub> /N <sub>2</sub> /Air	●	●	●
F5/Ar/H <sub>2</sub> O <sub>2</sub>		●	●
H <sub>2</sub> -N <sub>2</sub> -Ar Mixing			●

### Improved Torch Geometry

Superior bevel capability and performance thanks to an enhanced tapered torch design that features a 76° included angle and bevel rotation of up to 52°.

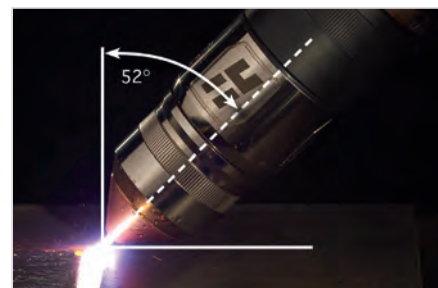

# EPL PLASMA

- TRUE HOLE
- EDGE CONNECT



## True Hole™ Technology

Standard

True Hole Technology, which has been developed for carbon steel, comes as standard with XPR 300 and automatic gas consollod of HPRXD® plasma system. Patented True Hole™ technology which was developed for carbon sheet, is a specific combination of cutting parameters which were optimised according to different hole sizes and material thicknesses.

With True Hole™, you acquire more consistent part dimensions and hence you need fewer second operations.

When this technology is compared with other plasma systems in the market, it provides enhancement in quality up to 50% in cylinder holes opened on carbon steel.

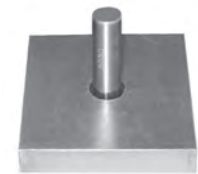
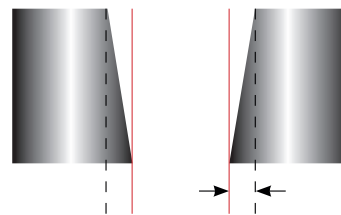

■ 12 mm hole cutting without True Hole Technology

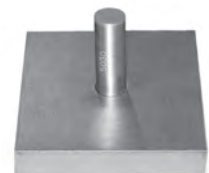

■ 12 mm hole cuts with True Hole Technology

## PRECISE HOLES WITH TRUE HOLE™ TECHNOLOGY...



### How is True Hole™ Technology obtained?

Achieved with EDGE® Connect Controller, Ermak THC, HPRXD®, XPR, Automatic gas system and ProNest® nesting software and well-matched cutting table.

True Hole™ technology of Hypertherm is a special combination of cutting parameters optimised for every single material thickness and hole dimensions

- Performed gas type
- Gas flow
- Amper
- Drilling method
- Input/output technique
- Cutting speed
- Timing





## New with EDGE® Connect CNC

- Hypertherm's Phoenix® version 10 CNC software
- Microsoft Windows 10 embedded operating system
- ProNest® CNC automatic nesting with process optimization
- Internal Programmable Logic Controller (PLC) and software based operator's console that enable unique cutting machine features
- EtherCAT machine interface for easy connectivity and superior motion
- Integrated 495 mm projected capacitive touch screen available on some models

## Easy to Use

Hypertherm's proprietary Phoenix software is common across the entire family of CNCs. This software is designed specifically for the X-Y and bevel cutting market. Through years of cutting experience, Hypertherm® engineers have learned the critical parameters to achieve superior cut quality on every part.

Phoenix CNC software improves cut quality and productivity by delivering our expertise directly to your factory, making it as if you have your best operator on every shift.

- Using the patented CutPro® Wizard, even new operators can be ready to cut production parts in less than five minutes
- On-screen Software Operator's Console (SoftOpCon) for easy setup and operation of cutting station and manual motion
- One touch access to supporting documentation including cutting optimization tips, consumable change instructions and diagnostic tools in multiple languages
- Integrated communications with plasma and torch height control systems deliver automated and expert control using installed factory or custom cut charts
- Custom cut chart scan can be created and controlled in the part program or made available to the CutPro Wizard
- Configurable Watch Windows™ enable on-screen real-time monitoring of key process performance parameters while cutting



■ Edge connect TC



■ Integrates the EDGE Connect CNC into an industrial enclosure with a 495 mm (19.5") touchscreen.



■ A hardware operator's console with switches for start, stop, program and manual speed control, raise/lower torch and joystick is included for easy operation.

# EPL PLASMA

## • GENERAL FEATURES

- Built-in cut charts for automatically setting process parameters for mild steel, stainless, and aluminum to enable consistently optimized cutting performance. Wizards and diagnostic support tools that enable easy setup, use and rapid troubleshooting.

As easy as 1, 2, 3, cut! : CutPro™ Wizard

- In field trials, new operators began cutting high-quality parts in less than 5 minutes without training, drastically reducing the “hire to cut” time.



1. Step : Select CNC program



2. Step : Select process



3. Step : Alling part / plate



Cut.

## Remote Help

- Remote Help is an internet based tool that allows the manufacturer to be virtually in your factory within minutes. CNC, plasma system and cutting table diagnosis and repair can often be accomplished without an on-site visit. This means that machines can be up and running quickly and without costly travel and wait time.

## Standard Features

Operating system	: Windows® Xpe
Hard Drive	: SATA drive
Display	: 15" glass touchscreen (surface acoustic wave technology)
Memory	: ≥1GB
USB interface	: Two USB 2.0 ports
Dimensions	: 435 mm (17.125") W; 463 mm (18.22") H; 316 mm (12.43") D
Temperature range	: -10° C to 40° C ambient (14° F to 104° F ambient)
Warranty	: Two-year warranty standard
Regulatory compliance	: CE, CSA
Operator's console	: Two-station Opcom standard
Operating voltage and frequency	: 100 – 240 V, 50/60 Hz
Software utilities	: Part Program Support (PPS), Remote Help, networking, Autogas support, DXF import, and simple shape nesting



## ProNest CAD/CAM Software

ProNest® is an industry leading CAD/CAM nesting software designed for advanced mechanized cutting.

It provides a single solution for all of your profile cutting needs, including plasma, laser, waterjet, and oxyfuel.

ProNest offers all of the standard features you'll need to complete your jobs, plus optional modules for more advanced functionality.

Users agree this powerful software is surprisingly easy to learn and use. Your team will be up and running faster, and completing jobs more quickly.

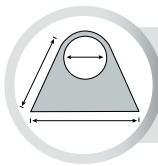

**PART DESIGN**  
Includes an integrated 2D CAD program and variable shape library.



**CAD IMPORT AND CONVERSION**  
Automatically prepares the part for nesting.



**JOB SET UP**  
Gives you control over materials, customers, plates, parts, and more.

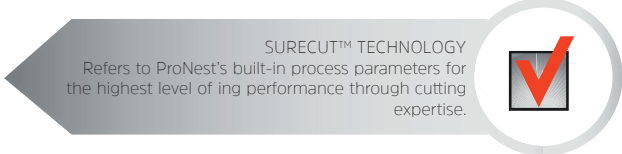

**SURECUT™ TECHNOLOGY**  
Refers to ProNest's built-in process parameters for the highest level of performance through cutting expertise.



**Nesting**  
Manual or automatic nesting makes it quick and easy to achieve your best nest.



**Output**  
Delivers the optimal NC code for cutting with virtually any machine.

ProNest is not just an item that runs your machines.

It is a key part of your entire cut and fabricated ecosystem, from bidding to part design, from reporting to stock management.

ProNest can even connect to ERP / MRP to exchange real-time data.



# EPL PLASMA

## • GENERAL FEATURES

### For a Better Quality Performance at Any Point

Ermaksan's high-quality and high-precision cutting machine, never compromising on quality, manufactured with the customer in mind, right down to the smallest detail.



#### Linear Guideways and Carriages

High-precision linear guideways and carriages are used in accordance with CE standards. So it provides high precision cutting results.

Germany origin Atlanta helical rack used in accordance with CE standards and provides high precision cutting results, increased sensitivity range and cut quality. Also the sound caused by friction is minimized. Thread quality is 9e27.

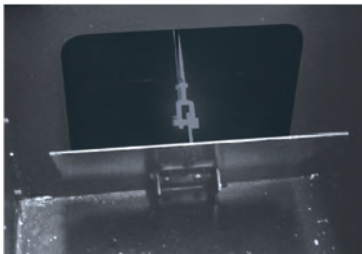

#### Cutting Table and Pneumatic Suction System

PLC software follows the cutting head movements and individual pneumatic flaps at related cutting sector open; proves high efficiency suction of waste gas, dust and fume from working environment.



#### Servo Motor and Planet Type Gear Box

Double driven synchronous brushless 3 pieces AC servo motors used on X and Y axes. With high-precision servo motor reaction times, drive and gear, high acceleration is provided.



#### Cable Tray

Comply with CE standards. Due to high quality plastic material used in the cable tray it encompasses quality, durability, resistance to abrasion, durability to heavy loads and resistance to breaks and protects the cable ducts.





## ERMAK THC

- Superior cutting quality and ideal consumables life with arc voltage sampling and control.
- Up to 80 % increases in parts per hour production by minimizing cut to cut cycle time.
- Ultimately strong mechanics under 2 years warranty.
- Easy to use human machine interface for under one minute fast job adjustment.
- Performance advantages are achievable with minimal operator input, eliminating the need for extensive training and allowing you to get the best performance across any shift with any operator at any plant.



■ ERMAK THC (Torch High Control)

### STANDARD EQUIPMENT

- Hypertherm EDGE Connect TC CNC
  - 19" LCD industrial type touch screen
  - Hypertherm operator panel
  - Safety module input and output
  - Ethercat communication system
  - Remote connection interface
  - Phoenix interface
  - Metric and inch gauges.
- Hypertherm® XPR300® Plasma Source
  - Hypertherm Core automatic gas console
  - Plasma Marking
- ERMAK THC Automatic High Control System
  - Ethercat communication system
  - Safety input-output interface module
  - Nozzle Sensor
  - Collision Sensor
  - 220 mm Standard Stroke
  - Laser Pointer
- ProNest® CAD / CAM Software
- 3 Axis (X, Y, Z)
  - 3 pieces Mitsubishi AC servo motor and driver
  - 3 pieces planet type Neugart gear box
  - High accuracy linear rails
  - High accuracy an silent Atlanta Helis rack and pinion
  - X,Y, Z Axis Iigus brand silent cable tray
- Cutting table with pneumatic system
- Pilz safety PLC Module
- 2 Emergency buttons
- 6 Mechanical stops

### OPTIONAL EQUIPMENT

- Hypertherm XPR300 VWI automatic gas console
- Hypertherm XPR300 Optimix automatic gas console
- Oxy-fuel cutting system
- Filter unit
- -/+45° manuel bevel cutting adaptor for oxy-fuel & Plasma
- 350 mm & 500 mm changeble stroke for oxy-fuel & Plasma
- Light barrier
- Air drier
- According to the working conditions cooling fan or heater can be add to the electrical panel
- Optional electrical voltage

# EPL PLASMA

## • TECHNICAL SPECIFICATIONS



TYPE	CUTTING WIDTH	TOTAL WIDTH	TOTAL HEIGHT	WEIGHT	TORCH DISTANCE	CUTTING LENGTH	TABLE HEIGHT	SPEED	MACHINE AXIS
	A	B	C	D	E				
	mm (inch)	mm (inch)	mm (inch)	mm (inch)	mm (inch)	mm (inch)	mm (inch)	m/min.	-
EPL 1530 COMPACT	1500 (59)	3250 (128)	2280 (90)	220 (8,6)	100 (4)	3000 (118)	900 (35)	35	X, Y, Z
EPL 2040 COMPACT	2000 (79)	3750 (148)	2280 (90)	220 (8,6)	100 (4)	4000 (157)	900 (35)	35	X, Y, Z
EPL2060	2000 (79)	3950 (156)	2280 (90)	220 (8,6)	100 (4)	6000 (236)	750 (30)	35	X, Y, Z
EPL 20120	2000 (79)	3950 (156)	2280 (90)	220 (8,6)	100 (4)	12000 (472)	750 (30)	35	X, Y, Z
EPL 2560	2500 (98)	4450 (175)	2280 (90)	220 (8,6)	100 (4)	6000 (236)	750 (30)	35	X, Y, Z
EPL 25120	2500 (98)	4450 (175)	2280 (90)	220 (8,6)	100 (4)	12000 (472)	750 (30)	35	X, Y, Z
EPL 3060	3000 (118)	4950 (195)	2280 (90)	220 (8,6)	100 (4)	6000 (236)	750 (30)	35	X, Y, Z
EPL 30120	3000 (118)	4950 (195)	2280 (90)	220 (8,6)	100 (4)	12000 (472)	750 (30)	35	X, Y, Z
EPL 4060	4000 (157)	6150 (242)	2280 (90)	220 (8,6)	100 (4)	6000 (236)	750 (30)	35	X, Y, Z
EPL 40120	4000 (157)	6150 (242)	2280 (90)	220 (8,6)	100 (4)	12000 (472)	750 (30)	35	X, Y, Z

\* All specifications subject to change without notice.

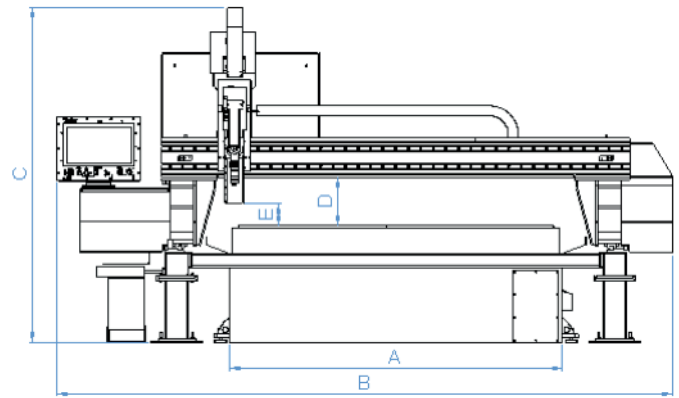
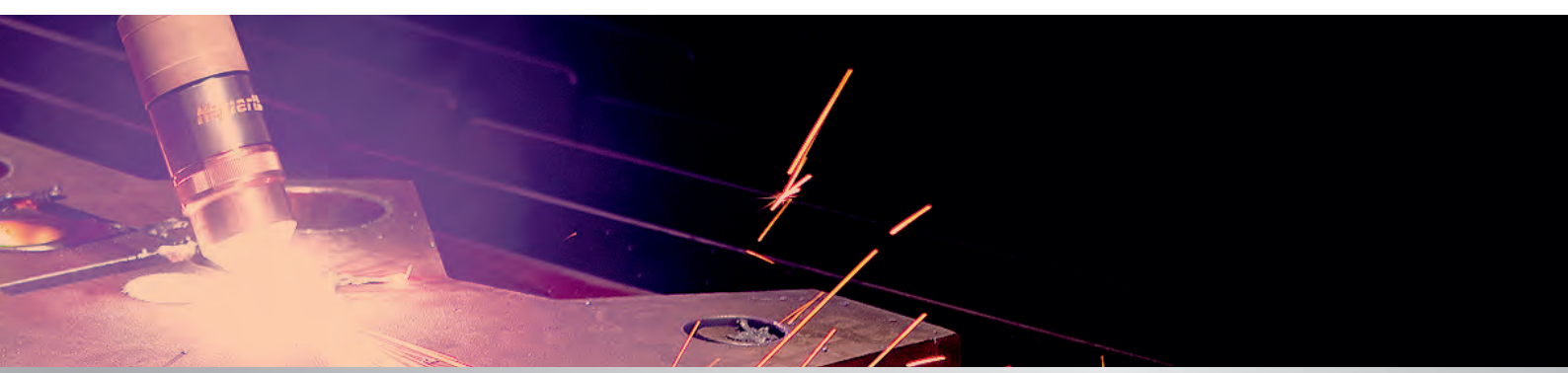

POSITIONING ACCURACY	POSITION REPEATABILITY ACCURACY	PLASMA CUTTING UNIT	TORCH HEIGHT CONTROL	CUTTING CAPACITY	ENERGY	WEIGHT
mm (inch)	mm (inch)			mm (inch)		kg (lbs)
± 0,1 DIN 28206 (± 0,0039 DIN 28206)	± 0,5 DIN 28206 (± 0,0019 DIN 28206)	Hypertherm XPR300	Ermak THC	1-80 (,039-3,14)	400V, 50Hz, 6 Bar Air	4100 (9051)
± 0,1 DIN 28206 (± 0,0039 DIN 28206)	± 0,5 DIN 28206 (± 0,0019 DIN 28206)	Hypertherm XPR300	Ermak THC	1-80 (,039-3,14)	400V, 50Hz, 6 Bar Air	5600 (12362)
± 0,1 DIN 28206 (± 0,0039 DIN 28206)	± 0,5 DIN 28206 (± 0,0019 DIN 28206)	Hypertherm XPR300	Ermak THC	1-80 (,039-3,14)	400V, 50Hz, 6 Bar Air	7100 (15673)
± 0,1 DIN 28206 (± 0,0039 DIN 28206)	± 0,5 DIN 28206 (± 0,0019 DIN 28206)	Hypertherm XPR300	Ermak THC	1-80 (,039-3,14)	400V, 50Hz, 6 Bar Air	12500 (27594)
± 0,1 DIN 28206 (± 0,0039 DIN 28206)	± 0,5 DIN 28206 (± 0,0019 DIN 28206)	Hypertherm XPR300	Ermak THC	1-80 (,039-3,14)	400V, 50Hz, 6 Bar Air	8150 (17991)
± 0,1 DIN 28206 (± 0,0039 DIN 28206)	± 0,5 DIN 28206 (± 0,0019 DIN 28206)	Hypertherm XPR300	Ermak THC	1-80 (,039-3,14)	400V, 50Hz, 6 Bar Air	14800 (32671)
± 0,1 DIN 28206 (± 0,0039 DIN 28206)	± 0,5 DIN 28206 (± 0,0019 DIN 28206)	Hypertherm XPR300	Ermak THC	1-80 (,039-3,14)	400V, 50Hz, 6 Bar Air	8900 (19647)
± 0,1 DIN 28206 (± 0,0039 DIN 28206)	± 0,5 DIN 28206 (± 0,0019 DIN 28206)	Hypertherm XPR300	Ermak THC	1-80 (,039-3,14)	400V, 50Hz, 6 Bar Air	15850 (34989)
± 0,1 DIN 28206 (± 0,0039 DIN 28206)	± 0,5 DIN 28206 (± 0,0019 DIN 28206)	Hypertherm XPR300	Ermak THC	1-80 (,039-3,14)	400V, 50Hz, 6 Bar Air	12350 (27263)
± 0,1 DIN 28206 (± 0,0039 DIN 28206)	± 0,5 DIN 28206 (± 0,0019 DIN 28206)	Hypertherm XPR300	Ermak THC	1-80 (,039-3,14)	400V, 50Hz, 6 Bar Air	22450 (49493)

# EPL PLASMA

• 3-AXIS HPR SERIES

## High Performance Maximum Productivity

Provides an optimum solution for all your requirements with its advanced precision cutting quality, and conformance to the production lines and automation. User-friendly CNC control unit with a wide range of software designed for plasma provide great convenience for the operator.

R&D engineering calculations are meticulously applied on the main body and the moving bridge of the EPL plasma cutting machine, which provide high cutting quality.

EPL Plasma Series is the machine with the best consumption of consumables available in the market. In terms of consumables and spare parts, Ermaksan offers very special advantages in prices for its customers of Hypertherm materials.

- High cutting speed
- Optimum efficiency
- Low cost of operation
- Simple operation
- Rigid monoblock body

### PRECISE CUTTING QUALITY

While providing high cutting quality thanks to the X-Definition technology, it also ensures that a precise cutting quality is achieved for a long period thanks to the HyFlow technology.

### OPTIMUM EFFICIENCY

Essential performance for your business with thicker material drilling up to 20% for stainless steel, and 30% for black sheet, and higher cutting speed up to 15% on thicker materials.





### **LOW OPERATING COSTS**

Provides more than 50% savings in operating costs while ensuring more than 40% increase in the life cycle of consumables.

### **RIGID BODY**

It may be used safely for many years thanks to its strong body machined with high precision and guaranteed for both dynamic and static rigidity.

# EPL PLASMA

- GENERAL FEATURES
- HPR XD SERIES



HyPerformance® offers quality and sensitive cuts along with high productivity. HPR XD® plasma sources offer better general performance, productivity and profitability with its unique combination of superior technologies.

## Power source and chiller

The addition of pump motor drives, fans, and eliminates the effect of frequency on the cooling water flow.



## Power Supply

- Self calibrating current control for better current adjustment.
- High power element/ productivity.
- Low fluctuation on exit current for lower arc voltage lapse and more stable plasma arc.
- Serial communication port on CNC for system surveillance.
- CAN serial communication between main modules for system stability.
- Long distance surveillance feature if CNC is connected to network.

## Manual Gas Console

- Provides HyDefinition cutting quality with LongLife Technology.
- Compensates for changes in the incoming gas pressure.
- Continuously measures and adjusts the flow of gas.

## Torch

Quick disconnect torch reduces installation time.

## HPRI30XD® Operating data

### Mild steel cut capacity

Dross free	16 mm (5/8")
Production pierce	32 mm (1-1/4")
Maximum cutting capacity	38 mm (1-1/2")

### Stainless steel cut capacity

Production pierce	20 mm (3/4")
Maximum cutting capacity	25 mm (1")

### Aluminum cut capacity

Production pierce	20 mm (3/4")
Maximum cutting capacity	25 mm (1")

## Life long cut quality (130 A)

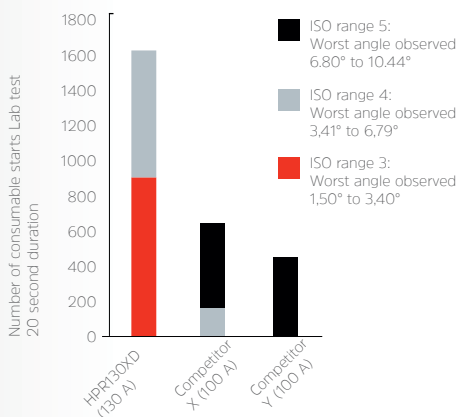

## Longer consumable life

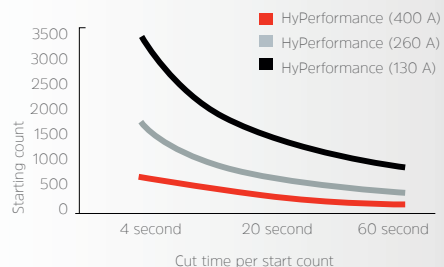

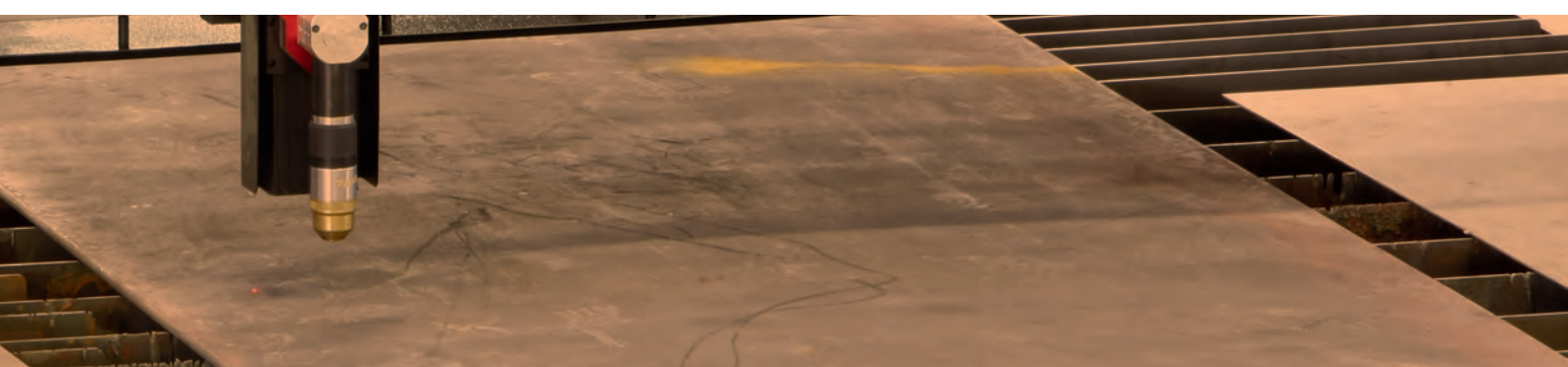

### Increased parts per hour

HyPerformance Plasma systems provide faster cut speeds to produce more parts per hour. Hypertherm's patented PowerPierce™ technology makes it possible to cut thicker than ever before and replace slow-cutting technologies such as oxyfuel. HyPerformance Plasma's superior quality and consistency maximize the number of parts produced per hour by minimizing time-consuming secondary operations.

### Do more with less power

HyPerformance Plasma enables extremely high cutting speeds per amp with less cutting current than other plasma solutions on the market.

### Longer consumable life

LongLife® and PowerPierce™ technologies significantly increase consumable life and reduce your cost per part. Hypertherm consumables are manufactured with the highest quality standards to ensure consistently longer life.

### Do more with less power

Patented consumable designs enable industry-leading cutting speeds and robust production piercing using lower amperage levels. HyPerformance Plasma enables extremely high cutting speeds per amp with less cutting current than other plasma solutions on the market. Hypertherm's power supplies are designed to be extremely efficient in their use of electricity, enabling lower electrical expense and a reduced impact on the environment.

### HPRXD plasma selections working data

	HPR400XD (30-400 amp)	HPR800XD (30-800 amp)
<b>Mild steel cutting capacity</b>		
• Dross free	38 mm (1-1/2")	38 mm (1-1/2")
• Production pierce	50 mm (2")	50 mm (2")
• Maximum cutting capacity	80 mm (3,2")	80 mm (3,2")
<b>Stainless steel cutting capacity</b>		
• Production pierce	45 mm (1-3/4")	75 mm (3")
• Maximum cutting capacity	80 mm (3,2")	160 mm (6-1/4")
<b>Aluminium cutting capacity</b>		
• Production pierce	45 mm (1-3/4")	75 mm (3")
• Maximum cutting capacity	80 mm (3,2")	160 mm (6-1/4")



### Automatic gas console option

- Allows full control of all plasma system settings from the CNC, simplifying operator training requirements.
- Automatically changes processes on the fly to enable rapid switching between cutting and marking.
- Automatically adjusts for variations in incoming gas pressure to produce the most consistent cutting performance.



# EPL PLASMA

## • HYPERTHERM HPRXD® PLASMA SOURCE

Ermaksan EPL series cutting machine provide more consistent cut quality and more powerful precision cutting which is Hypertherm's patented technologies.

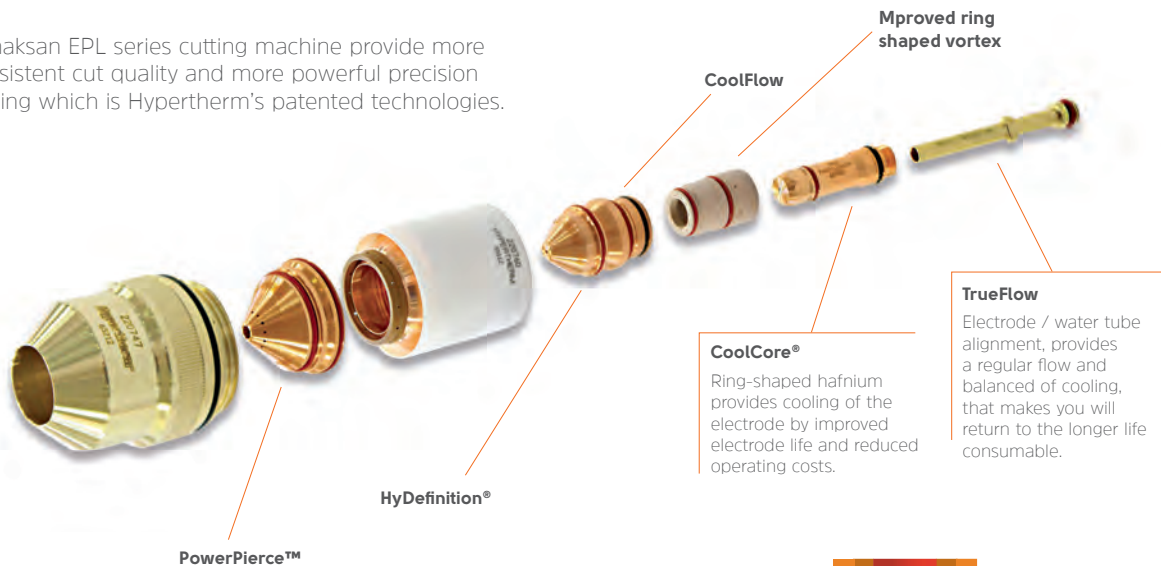

### HyDefinition® Technology

- Mouthed nozzle technology aligns and focuses the plasma arc.
- HyDefinition technology enables powerful precision cutting for superior quality and consistency.

### LongLife® Technology

- Hypertherm's patented LongLife® technology increase and decrease gas flow and gradually to reduce electrode and nozzle erosion in extremely controlled manner.
- By reducing erosion of electrode and nozzle with LongLife®, longer period with more consistent quality of a cut while offers a significant reduction in operating cost.

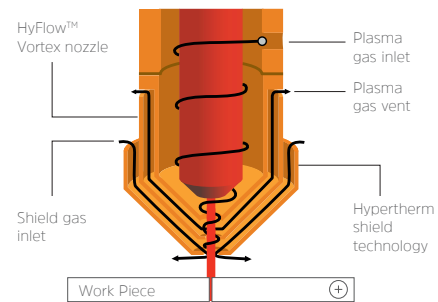

### LongLife timing diagram

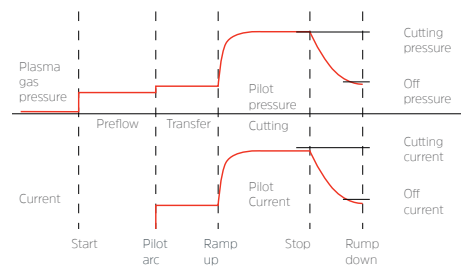

300 Pierces at 50 mm



With PowerPierce technology  
HPR400XD

41 Pierces at 45 mm

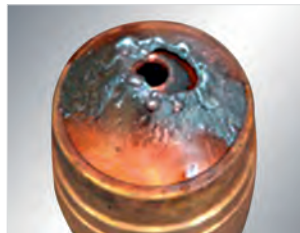

Without PowerPierce technology

### PowerPierce™ Technology

- Patented PowerPierce liquid cooled shield repels molten metal during piercing
- For maximum pierce capability of up to 50 mm mild steel and 75 mm stainless steel.
- Patented consumable designs deliver speed and thickness capabilities expected of higher amp systems





## Increase Parts Per Hour

Up to 100% improvement in parts cut per hour by rapid ignition and movement optimization coded on software.



Example part 203 mm flange

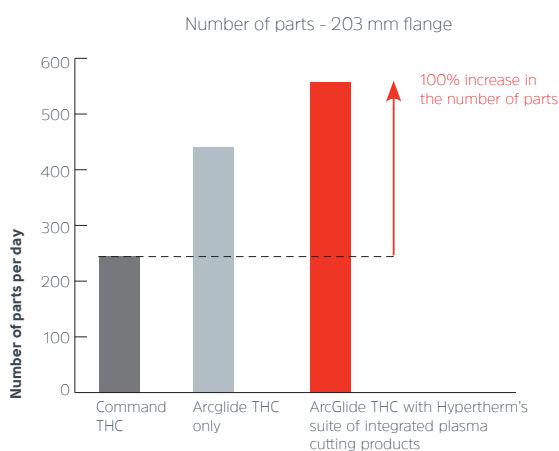
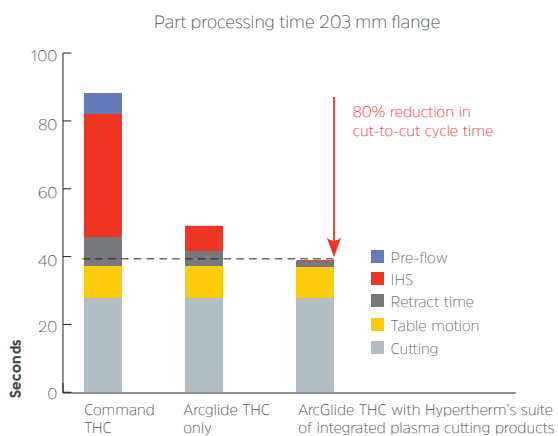

## Decrease Cost Per Part

ArcGlide THC continuously samples arc voltage and automatically adjusts arc voltage for proper torch height over the life of the consumables without requiring operator input.

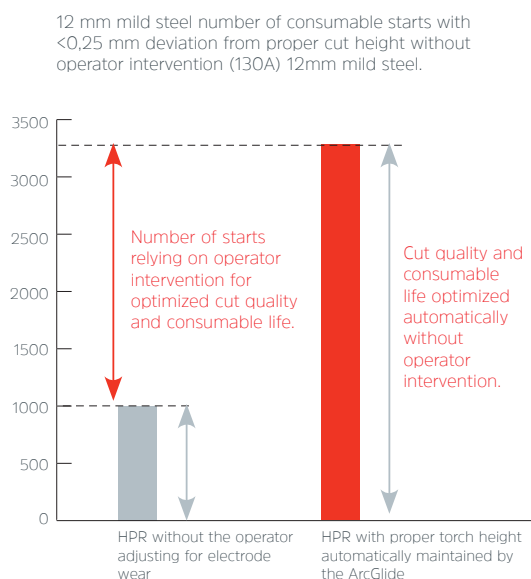

Improper cut height due to not adjusting arc voltage for electrode wear

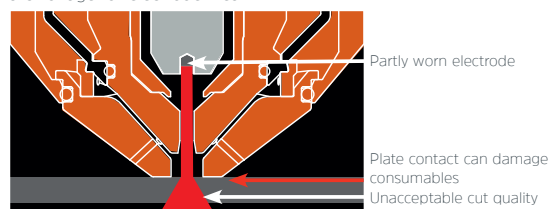

Consumables discarded prematurely

Proper cut height automatically maintained by ArcGlide THC

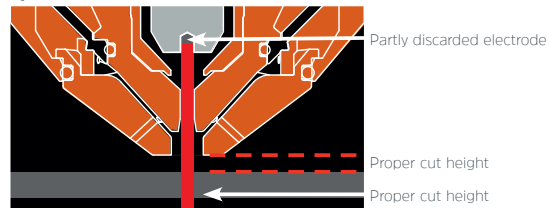

Consumable life and cut quality optimized

# EPL PLASMA

- PRONEST LT SOFTWARE

## ProNest® LT Nesting Software

### Part creation and development

- Integrated 2D CAD program to create and edit CAD files
- Variable Shape Parts feature to develop common parts from templates

### CAD/CAM import and conversion

- Import CAD and CNC files (many industry-standard file formats) Import Bill of Materials properties from CAD files
- Automatic CAD file correction and error notification
- Automatic spline / ellipse smoothing and reduction
- Separate multiple parts from a single CAD file
- Automatic mapping of CAD layers to processes (cut, mark, etc.)

### Interactive manual nesting

- Group parts into clusters for nesting
- Drag, drop and bump parts on the nest
- Duplicate, move, scale, mirror, rotate, or array parts
- Prohibit / permit nesting inside of a part
- Multi-sheet and multi-head nesting
- Part interference detection
- Edit lead-in / out position and properties within the nest Automatically update nest with part revisions
- Grain constraint, automatic tabbing / micro-joints, edge pierce technology
- Material database (with grade and gauge), plate list and part library
- Manual and automatic plate cropping
- Safe zones for plate clamping applications
- Automatic and manual nest sequencing
- Control cut direction and cut sequencing on part-by-part basis
- Animated cutting sequence simulation Built-in process parameters

### Built-in process parameters

- Material type, thickness, grade and class-based process parameters
- Material type and thickness based lead-in/out parameters
- Automatic and interactive separations for part, plate, and pierce spacing

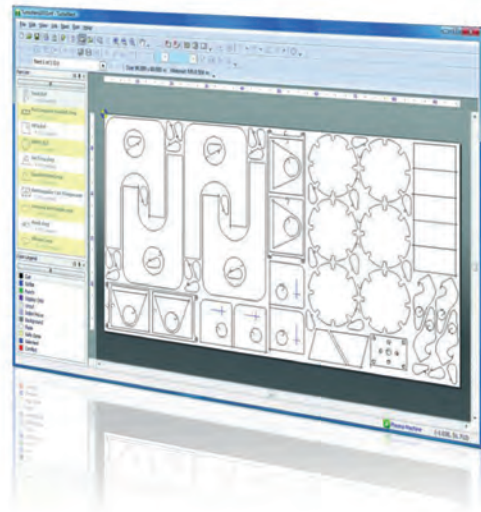

### Reporting

- Customizable management and shop reports
- Export reports directly to PDF, Excel spreadsheet (\*.xls), or (\*.csv)

### Costing

- Detailed user-defined machine and labor production costing
- Automatic calculation of part production costs and part/nest utilization

## Advantage+

- Better productivity
- Improved part quality
- User friendly
- Fast learning curve
- More efficient use
- Fewer errors

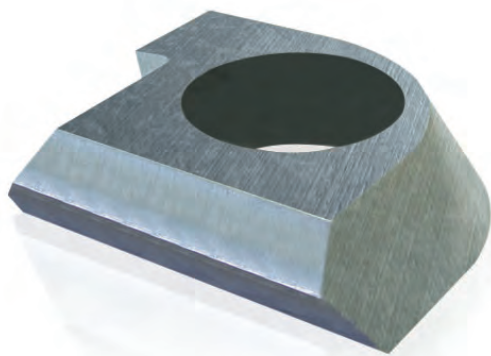

### STANDARD EQUIPMENT

- Hypertherm EDGE Connect TC CNC
  - 19" LCD industrial type touch screen
  - Hypertherm operator panel
  - Safety module input and output
  - Ethercat communication system
  - Remote connection interface
  - Phoenix interface
  - Metric and inch gauges.
- Hypertherm® HPR130XD Plasma Source
  - Hypertherm Manual Gas console
  - Plasma marking
- ERMAK THC Automatic High Control System
  - Ethercat communication system
  - Safety input-output interface module
  - Nozzle Sensor
  - Collision Sensor
  - 220 mm Standard Stroke
  - Laser Pointer
- ProNest® LT CAD / CAM Software
- 3 Axis (X, Y, Z)
  - 3 pieces Mitsubishi AC servo motor and driver
  - 3 pieces planet type Neugart gear box
  - High accuracy linear rails
  - High accuracy an silent Atlanta Hells rack and pinion
  - X,Y, Z Axis Iigus brand silent cable tray
- Cutting table with pneumatic system
- Pilz safety PLC Module
- 2 Emergency buttons
- 6 Mechanical stops

### OPTIONAL EQUIPMENT

- Hypertherm HPR130XD automatic gas console
- Hypertherm HPR400XD manual gas console
- Hypertherm HPR400XD automatic gas console
- Hypertherm HPR800XD manual gas console
- Hypertherm HPR800XD automatic gas console
- Oxy-fuel cutting system
- Filter unit
- -/+45° manual bevel cutting adaptor for oxy-fuel & Plasma
- 350 mm & 500 mm changeble stroke for oxy-fuel & Plasma
- True hole™ technology
- Light barrier
- Air drier
- According to the working conditions cooling fan or heater can be add to the electrical panel
- Optional electrical voltage



# EPL PLASMA

## • TECHNICAL SPECIFICATIONS

TYPE	CUTTING WIDTH	TOTAL WIDTH	TOTAL HEIGHT	WEIGHT	TORCH DISTANCE	CUTTING LENGTH	TABLE HEIGHT	SPEED	MACHINE AXIS
	A	B	C	D	E				
	mm (inch)	mm (inch)	mm (inch)	mm (inch)	mm (inch)	mm (inch)	mm (inch)	m/min.	-
EPL 1530 COMPACT	1500 (59)	3250 (128)	2280 (90)	220 (8,6)	100 (4)	3000 (118)	900 (35)	35	X, Y, Z
EPL 2040 COMPACT	2000 (79)	3750 (148)	2280 (90)	220 (8,6)	100 (4)	4000 (157)	900 (35)	35	X, Y, Z
EPL2060	2000 (79)	3950 (156)	2280 (90)	220 (8,6)	100 (4)	6000 (236)	750 (30)	35	X, Y, Z
EPL 20120	2000 (79)	3950 (156)	2280 (90)	220 (8,6)	100 (4)	12000 (472)	750 (30)	35	X, Y, Z
EPL 2560	2500 (98)	4450 (175)	2280 (90)	220 (8,6)	100 (4)	6000 (236)	750 (30)	35	X, Y, Z
EPL 25120	2500 (98)	4450 (175)	2280 (90)	220 (8,6)	100 (4)	12000 (472)	750 (30)	35	X, Y, Z
EPL 3060	3000 (118)	4950 (195)	2280 (90)	220 (8,6)	100 (4)	6000 (236)	750 (30)	35	X, Y, Z
EPL 30120	3000 (118)	4950 (195)	2280 (90)	220 (8,6)	100 (4)	12000 (472)	750 (30)	35	X, Y, Z
EPL 4060	4000 (157)	6150 (242)	2280 (90)	220 (8,6)	100 (4)	6000 (236)	750 (30)	35	X, Y, Z
EPL 40120	4000 (157)	6150 (242)	2280 (90)	220 (8,6)	100 (4)	12000 (472)	750 (30)	35	X, Y, Z

\* All specifications subject to change without notice.

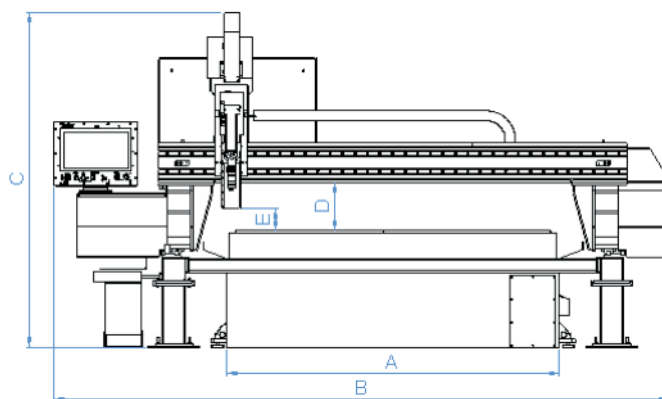

POSITIONING ACCURACY	POSITION REPEATABILITY ACCURACY	PLASMA CUTTING UNIT	TORCH HEIGHT CONTROL	CUTTING CAPACITY	ENERGY	WEIGHT
mm (inch)	mm (inch)			mm (inch)		kg (lbs)
± 0,1 DIN 28206 (± 0,0039 DIN 28206)	± 0,5 DIN 28206 (± 0,0019 DIN 28206)	Hypertherm HPR130XD	Ermak THC	1-38 (.039 - 1.49)	400V, 50Hz, 6 Bar Air	4100 (9051)
± 0,1 DIN 28206 (± 0,0039 DIN 28206)	± 0,5 DIN 28206 (± 0,0019 DIN 28206)	Hypertherm HPR130XD	Ermak THC	1-38 (.039 - 1.49)	400V, 50Hz, 6 Bar Air	5600 (12362)
± 0,1 DIN 28206 (± 0,0039 DIN 28206)	± 0,5 DIN 28206 (± 0,0019 DIN 28206)	Hypertherm HPR130XD	Ermak THC	1-38 (.039 - 1.49)	400V, 50Hz, 6 Bar Air	7100 (15673)
± 0,1 DIN 28206 (± 0,0039 DIN 28206)	± 0,5 DIN 28206 (± 0,0019 DIN 28206)	Hypertherm HPR130XD	Ermak THC	1-38 (.039 - 1.49)	400V, 50Hz, 6 Bar Air	12500 (27594)
± 0,1 DIN 28206 (± 0,0039 DIN 28206)	± 0,5 DIN 28206 (± 0,0019 DIN 28206)	Hypertherm HPR130XD	Ermak THC	1-38 (.039 - 1.49)	400V, 50Hz, 6 Bar Air	8150 (17991)
± 0,1 DIN 28206 (± 0,0039 DIN 28206)	± 0,5 DIN 28206 (± 0,0019 DIN 28206)	Hypertherm HPR130XD	Ermak THC	1-38 (.039 - 1.49)	400V, 50Hz, 6 Bar Air	14800 (32671)
± 0,1 DIN 28206 (± 0,0039 DIN 28206)	± 0,5 DIN 28206 (± 0,0019 DIN 28206)	Hypertherm HPR130XD	Ermak THC	1-38 (.039 - 1.49)	400V, 50Hz, 6 Bar Air	8900 (19647)
± 0,1 DIN 28206 (± 0,0039 DIN 28206)	± 0,5 DIN 28206 (± 0,0019 DIN 28206)	Hypertherm HPR130XD	Ermak THC	1-38 (.039 - 1.49)	400V, 50Hz, 6 Bar Air	15850 (34989)
± 0,1 DIN 28206 (± 0,0039 DIN 28206)	± 0,5 DIN 28206 (± 0,0019 DIN 28206)	Hypertherm HPR130XD	Ermak THC	1-38 (.039 - 1.49)	400V, 50Hz, 6 Bar Air	12350 (27263)
± 0,1 DIN 28206 (± 0,0039 DIN 28206)	± 0,5 DIN 28206 (± 0,0019 DIN 28206)	Hypertherm HPR130XD	Ermak THC	1-38 (.039 - 1.49)	400V, 50Hz, 6 Bar Air	22450 (49493)

# EPL 5 AXIS PLASMA

- PLASMA CUTTING

## Bring a New Dimension to your Cutting Operations...

Provides an advanced solution where more than one angled cuts are possible. Allows savings from additional operations by cutting different contours without slag. Processes aluminium, stainless and normal sheet types very flexibly. Automatic angle adjustment technology minimizes the production time.

True bevel technology

Low cost of operation

Ergonomic design

Simple operation

True hole™ technology



### TRUE HOLE™ TECHNOLOGY

Patented True Hole™ technology developed for carbon sheets is a specific combination of cutting parameters optimized by different hole dimensions and material thickness values. True Hole™ technology removes the angles and distortions on the holes completely.

### MORE WORK IN LESS TIME

Saves you time by minimizing the production time thanks to its automatic angle adjustment technology.





### EASE OF USE

All angles are calculated automatically in 5-axis cutting technology. The angle value that shall be entered manually by the operator during the cutting operation is generated automatically.

### FLEXIBLE SOLUTIONS

Provides ease of use for the operator while offering its users flexible solutions with its structure suitable for automation.

# EPL 5 AXIS PLASMA

## • GENERAL FEATURES

### 5 Axis Cutting Head

All angles are calculated automatically with 5 axis cutting technology. During the cutting process, it composes the angle value automatically, which the operator needs to enter. 5 axis cutting technology is a perfect solution for vertical and angular cuts.

Automatic angle adjustment provides time saving to the operator and removes the issues which could be caused by operator errors.

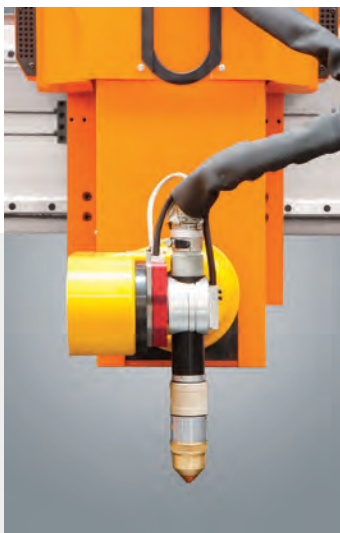

■ Cutting head moves up and down with Z axis right and left with x axis.



■ Can move totally +50 and 60° degrees at A axis.



■ Can move totally +50 and 60° degrees at B axis.



25 mm Mild Steel



25 mm Mild Steel



25 mm Mild Steel





## True Bevel Technology

As part of Hypertherm's SureCut™ technology, True Bevel™ technology for HPRXD® and XPR™ plasma systems is a performance application for mild steel. Factory tested and easily implemented, it takes the guesswork out of the plasma bevel-cutting process. With True Bevel, setups for new jobs are quick and results are accurate and consistent.

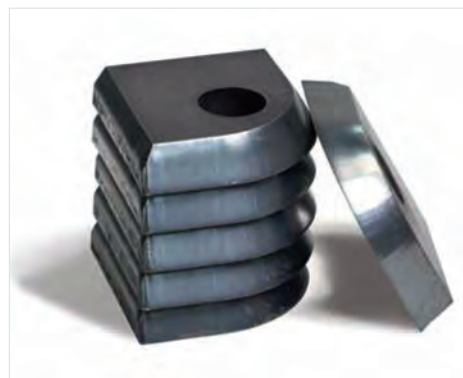

## Benefits

- Automatically bolt hole without operator intervention quality offered
- Close the gap between the laser hole quality and the plasma process.

makes it a convenient option for many laser-cut jobs

- Completely eliminates hole taper
- Resonant is minimal and deflected out of the hole
- Provides true bolt hole "quality"



## Bevel Angle & Land Density Coverage

True Bevel™ for XPR300® has angle coverage for V and Top Y cuts up to 50° and A cuts up to 45°. The tables contain values for lands ranging from 20% to 50% of the material thickness for Y Top cuts. You can add other angles and land dimensions within the specified ranges into the bevel process parameter tables for more flexibility. The tables automatically provide newly calculated output values for angle compensation, kerf, cut height, cut speed, and arc voltage.





# EPL 5 AXIS PLASMA

## • GENERAL FEATURES

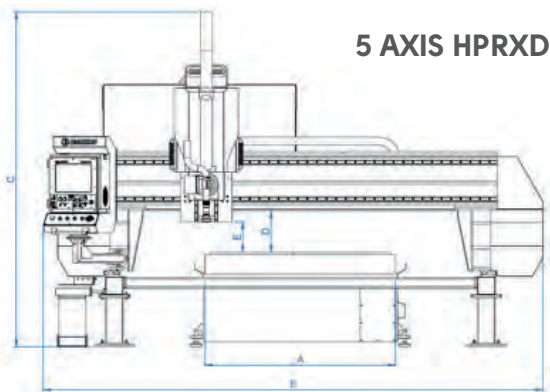

**5 AXIS HPRXD**

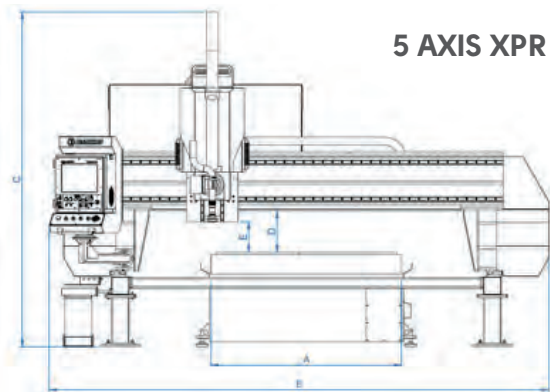

**5 AXIS XPR**

### STANDARD EQUIPMENT

- Hypertherm EDGE Connect TC CNC
  - 19" LCD industrial type touch screen
  - Hypertherm operator panel
  - Safety module input and output
  - Ethercat communication system
  - Remote connection interface
  - Phoenix interface
  - Metric and inch gauges.
- Hypertherm HPR130XD Plasma Source
  - Hypertherm automatic Gas console
  - Plasma marking
- ERMAK THC Automatic High Control System
  - Ethercat communication system
  - Safety input-output interface module
  - Nozzle Sensor
  - Collision Sensor
  - 300 mm Standard Stroke
  - Laser Pointer
- 5 Axis cutting head IMATECHNO
- ProNest® CAD / CAM software
- 5 Axis (X, Y, Z, A, B)
  - 5 pieces Mitsubishi AC servo motor and driver
  - 5 pieces planet type Neugart gear box
  - High accuracy linear rails
  - High accuracy an silent Atlanta Helis rack and pinion
  - X,Y, Z, Axis Iigus brand silent cable tray
- Cutting table with pneumatic system
- Pilz safety PLC Module
- 2 Emergency buttons
- 6 Mechanical stops
- True Hole™ technology
- True Bevel™ technology

### OPTIONAL EQUIPMENT

- Hypertherm HPR400XD automatic gas console
- Hypertherm HPR800XD automatic gas console
- Hypertherm XPR 300 Core automatic gas console
- Hypertherm XPR 300 VWI automatic gas console
- Hypertherm XPR 300 Optimix automatic gas console
- Oxy-fuel cutting system
- Filter unit
- -/+45° manual bevel cutting adaptor for oxy-fuel & Plasma
- 350 mm & 500 mm changeble stroke for oxy-fuel & Plasma
- Light barrier
- Air drier
- According to the working conditions cooling fan or heater can be add to the electrical panel
- Optional electrical voltage



## 5 AXIS HPRXD TECHNICAL SPECIFICATIONS

		EPL 1530	EPL 2040	EPL 2060	EPL 20120	EPL 2560	EPL 25120	EPL 3060	EPL 30120	EPL 4060	EPL 40120
CUTTING WIDTH (A)	mm (inch)	1500 (59)	2000 (79)	2000 (79)	2000 (79)	2500 (98)	2500 (98)	3000 (118)	3000 (118)	4000 (157)	4000 (157)
TOTAL WIDTH (B)	mm (inch)	4200 (165)	4700 (185)	4700 (185)	4700 (185)	5200 (205)	5200 (205)	5700 (224)	5700 (224)	6400 (252)	6400 (252)
TOTAL HEIGHT (C)	mm (inch)	2280 (90)	2280 (90)	2280 (90)	2280 (90)	2280 (90)	2280 (90)	2280 (90)	2280 (90)	2280 (90)	2280 (90)
WEIGHT (D)	mm (inch)	290 (11)	290 (11)	290 (11)	290 (11)	290 (11)	290 (11)	290 (11)	290 (11)	290 (11)	290 (11)
TORCH DISTANCE (E)	mm (inch)	300 (12)	300 (12)	300 (12)	300 (12)	300 (12)	300 (12)	300 (12)	300 (12)	300 (12)	300 (12)
CUTTING LENGHT	mm (inch)	3000 (118)	4000 (157)	6000 (236)	12000 (472)	6000 (236)	12000 (472)	6000 (236)	12000 (472)	6000 (236)	12000 (472)
TABLE HEIGHT	mm (inch)	750 (30)	750 (30)	750 (30)	750 (30)	750 (30)	750 (30)	750 (30)	750 (30)	750 (30)	750 (30)
SPEED	m/min.	20	20	20	20	20	20	20	20	20	20
MACHINE AXIS	-	X, Y, Z, A, B									
POSITIONING ACCURACY	mm (inch)	± 0,01 DIN 28206 (± 0,0039 DIN 28206)									
POSITION REPEATABILITY ACCURACY	mm (inch)	± 0,05 DIN 28206 (± 0,0019 DIN 28206)									
PLASMA CUTTING UNIT		Hypertherm HPR130XD									
TORCH HEIGHT CONTROL		Ermak THC									
CUTTING CAPACITY	mm (inch)	1-38 (.039 - 1.49)	1-38 (.039 - 1.49)	1-38 (.039 - 1.49)	1-38 (.039 - 1.49)	1-38 (.039 - 1.49)	1-38 (.039 - 1.49)	1-38 (.039 - 1.49)	1-38 (.039 - 1.49)	1-38 (.039 - 1.49)	1-38 (.039 - 1.49)
ENERGY		400V, 50Hz, 6 Bar Air									
WEIGHT	kg (lbs)	5150 (11369)	6650 (14680)	8150 (17991)	13550 (29912)	9200 (20309)	15850 (34989)	9950 (21965)	16900 (37307)	13400 (29581)	23500 (51876)

## 5 AXIS XPR TECHNICAL SPECIFICATIONS

PLASMA CUTTING UNIT

Hypertherm XPR 300

CUTTING CAPACITY	mm (inch)	1-80 (.039-3,14)	1-80 (.039-3,14)	1-80 (.039-3,14)	1-80 (.039-3,14)	1-80 (.039-3,14)	1-80 (.039-3,14)	1-80 (.039-3,14)	1-80 (.039-3,14)	1-80 (.039-3,14)	1-80 (.039-3,14)
WEIGHT	kg (lbs)	5500 (12141)	7000 (15453)	8500 (18764)	13900 (30684)	9550 (21082)	16200 (35762)	10300 (22737)	17250 (38079)	13750 (30353)	23850 (52649)

\* All specifications subject to change without notice.

# EPL PIPE & PROFILE CUTTING

- PLASMA CUTTING

## Impressive Solutions for Tube Cutting...

Ermaksan has designed EPL Plasma series to cut tubes from 50 to 400 mm in diameter precisely with its tube cutting technology. Cuts profiles between 100 and 600 mm. Tube cutting has a wide range of application such as tanks, pipe lines, power plants, etc. Profile cutting is used for construction, defence industries, and it provides angled cuts with the 5-axis cutting head provided optionally if desired.

It is designed to meet the tube cutting requirements of the industry on steel construction in the best way. These machines are used in a wide range from construction industry to defence and machinery industries.



- ▶ Tube and profile cutting technology
- ▶ Low cutting cost
- ▶ Ergonomic design
- ▶ Simple operation
- ▶ Filtering system
- ▶ Marking

### TUBE AND PROFILE CUTTING TECHNOLOGY

Ermaksan EPL Plasma series cutting machines allow high precision cutting of 100mm to 600mm square and rectangular profiles. Optionally, production with desired dimensions and applications is also possible.

### PRECISE CUTTING

Allows you achieve quality, reliable and precise cuts with the Hypertherm XD® plasma welding.



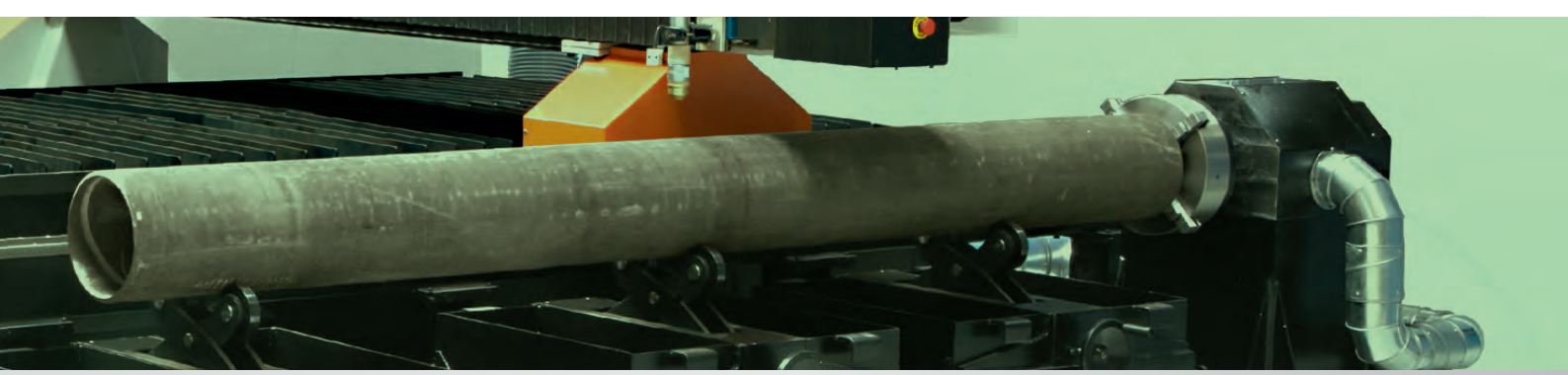

### **FILTERING SYSTEM**

Filtering system with perfect efficiency thanks to suction from the inside of the tube that is designed to meet the plasma cutting standards at high speed.

### **FLEXIBLE SOLUTIONS**

It is designed to ensure precise machining of tubes and profiles beside the metal plates in order to meet the requirements of the industry.

# EPL PIPE & PROFILE CUTTING

## • GENERAL FEATURES



Rotary Tube Pro™ provides a complete design and cutting solution for tube and pipe parts without the need for 3D CAD experience. Using standard parameters, tubes and branches can be easily identified within the software interface. Side wall silhouettes can be added from CAD or from a list of pre-defined shapes.



- Sensitive and qualified cuts with Hypertherm XD® plasma source
- Meeting the high speed plasma cutting standards with impeccable filtration system thanks to inner pipe suction design.
- High precision for edge cuts and round cuts with the milled teeth helical rack and pinion.
- Manual support system that provides 50 – 400 diameter pipe cuts.
- Advanced Height control unit designed for plasma cutting.
- A design that protects mechanical parts from fumes or impacts.
- EDGE Connect CNC control unit is easy to use and efficient
- Software Rotary TubePro Cad/Cam
- Marking speciality
- Feature of returning backward and continue to cut where ever needed.
- Large utilization area like tank manufacturing, pipe line etc.

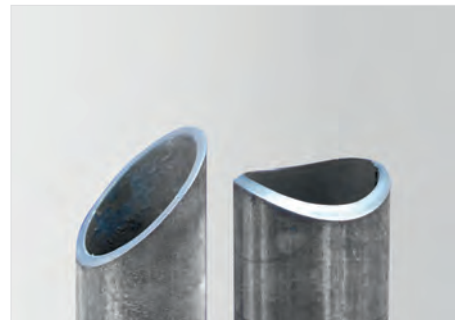

■ You can also make angled cuts with the optional 5-axis cutting head.



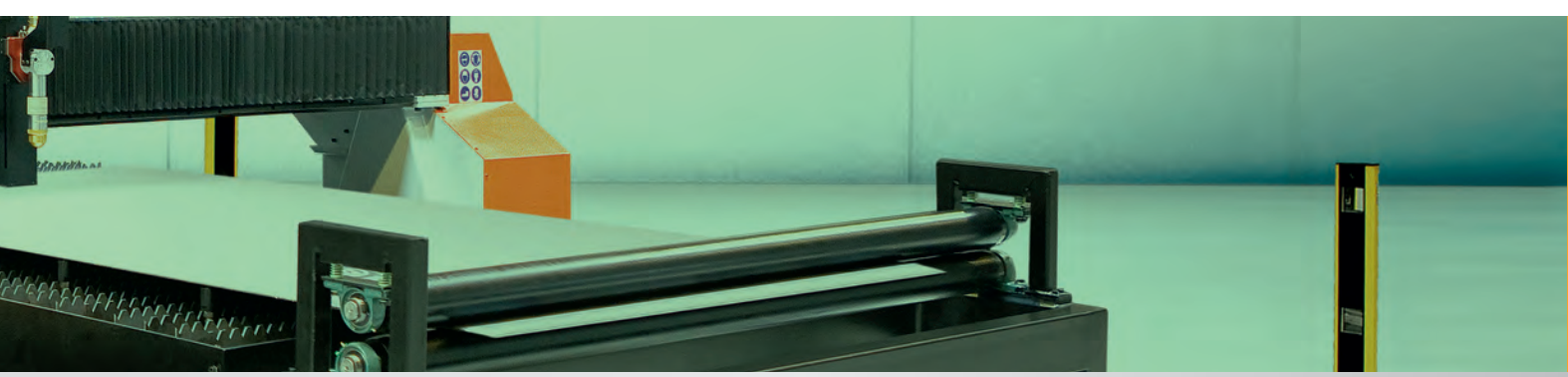

Rotary Tube Pro™ supports almost all tube cutting machine brands, including stand-alone units and cutting table add-ons. The software supports bevel cutting as a standard feature and bevel cutting as an optional module.





# EPL PIPE & PROFILE CUTTING

## • GENERAL FEATURES

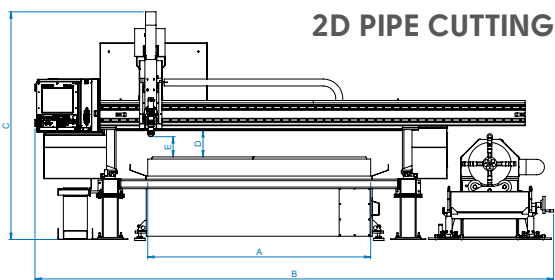

**2D PIPE CUTTING**

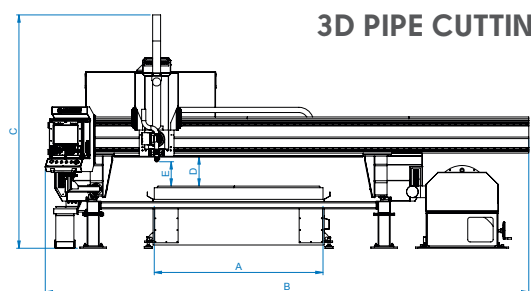

**3D PIPE CUTTING**

### STANDARD EQUIPMENT

- Hypertherm EDGE Connect TC CNC
  - 19" LCD industrial type touch screen
  - Hypertherm operator panel
  - Safety module input and output
  - Ethercat communication system
  - Remote connection interface
  - Phoenix interface
  - Metric and inch gauges.
- Hypertherm® HPR130XD Plasma Source
  - Hypertherm manual Gas console
  - Plasma marking
- ERMAK THC Automatic High Control System
  - Ethercat communication system
  - Safety input-output interface module
  - Nozzle Sensor
  - Collision Sensor
  - 400 mm Standard Stroke
  - Laser Pointer
- Chuck and centering mechanism
- Rotary Tube Pro™ CAD / CAM Software
- ProNest® LT CAD / CAM Software
- 4 Axis (X, Y, Z, D)
  - 4 pieces Mitsubishi AC servo motor and driver
  - 4 pieces planet type Neugart gear box
  - High accuracy linear rails
  - High accuracy an silent Atlanta Helis rack and pinion
  - X,Y, Z, Axis Igus brand silent cable tray
- Cutting table with pneumatic system
- Pilz safety PLC Module
- 2 Emergency buttons
- 6 Mechanical stops

### OPTIONAL EQUIPMENT

- Hypertherm HPR130XD automatic gas console
- Hypertherm HPR400XD manual gas console
- Hypertherm HPR400XD automatic gas console
- Hypertherm HPR800XD manual gas console
- Hypertherm HPR800XD automatic gas console
- Hypertherm XPR 300 Core automatic gas console
- Hypertherm XPR 300 VWI automatic gas console
- Hypertherm XPR 300 Optimix automatic gas console
- Oxy-fuel cutting system
- Filter unit
- -/+45° manual bevel cutting adaptor for oxy-fuel & Plasma
- 350 mm & 500 mm changeable stroke for oxy-fuel & Plasma
- Light barrier
- Air drier
- According to the working conditions cooling fan or heater can be add to the electrical panel
- Optional electrical voltage
- True Hole™ technology
- True Bevel™ technology
- 5 Axis Bevel Head IMATECHNO

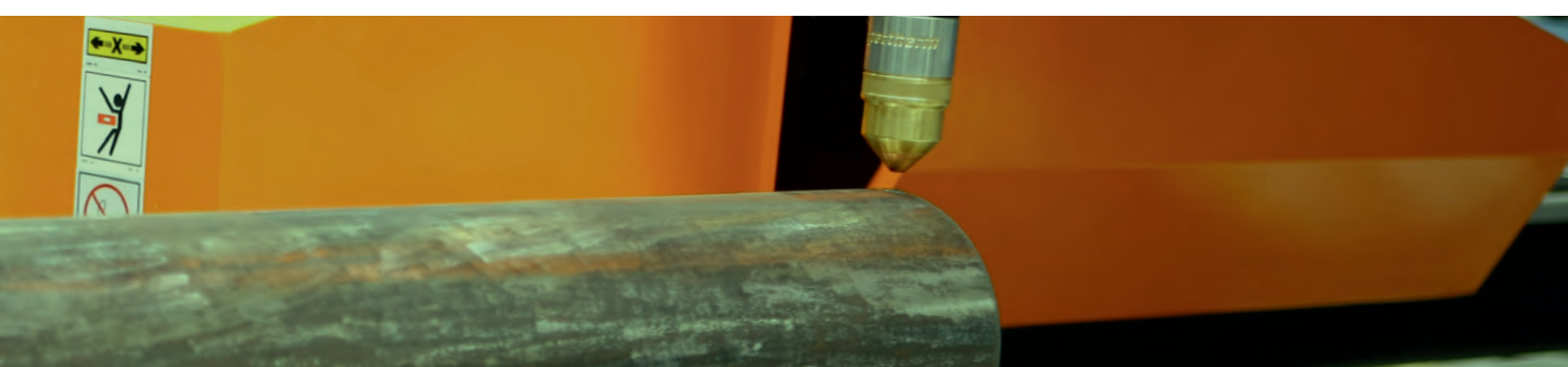

## TECHNICAL SPECIFICATIONS OF 2D PIPE CUTTING

		EPL 1530	EPL 2040	EPL 2060	EPL 20120	EPL 2860	EPL 25120	EPL 3060	EPL 30120	EPL 4060	EPL 40120
CUTTING WIDTH (A)	mm (inch)	1500 (59)	2000 (79)	2000 (79)	2000 (79)	2500 (98)	2500 (98)	3000 (118)	3000 (118)	4000 (157)	4000 (157)
TOTAL WIDTH (B)	mm (inch)	4400 (173)	4900 (193)	4900 (193)	4900 (193)	5400 (213)	5400 (213)	5900 (232)	5900 (232)	6900 (272)	6900 (272)
TOTAL HEIGHT (C)	mm (inch)	2280 (90)	2280 (90)	2280 (90)	2280 (90)	2280 (90)	2280 (90)	2280 (90)	2280 (90)	2280 (90)	2280 (90)
WEIGHT (D)	mm (inch)	250 (10)	250 (10)	250 (10)	250 (10)	250 (10)	250 (10)	250 (10)	250 (10)	250 (10)	250 (10)
TORCH DISTANCE (E)	mm (inch)	0-400 (0-15,7)	0-400 (0-15,7)	0-400 (0-15,7)	0-400 (0-15,7)	0-400 (0-15,7)	0-400 (0-15,7)	0-400 (0-15,7)	0-400 (0-15,7)	0-400 (0-15,7)	0-400 (0-15,7)
CUTTING LENGHT	mm (inch)	3000 (118)	4000 (157)	6000 (236)	12000 (472)	6000 (236)	12000 (472)	6000 (236)	12000 (472)	6000 (236)	12000 (472)
TABLE HEIGHT	mm (inch)	750 (30)	750 (30)	750 (30)	750 (30)	750 (30)	750 (30)	750 (30)	750 (30)	750 (30)	750 (30)
SPEED	m/min.	20	20	20	20	20	20	20	20	20	20
MACHINE AXIS	-	X, Y, Z, D									
PIPE CUTTING DIAMETER MIN. MAX.	mm (inch)	Ø50-Ø400 (1,9-15,7)									
PIPE CUTTING MAX. THICKNESS (MILD STEEL)	mm (inch)	20 (,79)	20 (,79)	20 (,79)	20 (,79)	20 (,79)	20 (,79)	20 (,79)	20 (,79)	20 (,79)	20 (,79)
POSITIONING ACCURACY	mm (inch)	± 0,01 DIN 28206 (± 0,0039 DIN 28206)									
POSITION REPEATABILITY ACCURACY	mm (inch)	± 0,05 DIN 28206 (± 0,0019 DIN 28206)									
PLASMA CUTTING UNIT		Hypertherm HPR130XD									
TORCH HEIGHT CONTROL		Ermak THC									
CUTTING CAPACITY	mm (inch)	1-38 (,039 - 1,49)	1-38 (,039 - 1,49)	1-38 (,039 - 1,49)	1-38 (,039 - 1,49)	1-38 (,039 - 1,49)	1-38 (,039 - 1,49)	1-38 (,039 - 1,49)	1-38 (,039 - 1,49)	1-38 (,039 - 1,49)	1-38 (,039 - 1,49)
ENERGY		400V, 50Hz, 6 Bar Air									
WEIGHT	kg (lbs)	5200 (11479)	6600 (14570)	8800 (19426)	15350 (33885)	9700 (21413)	17200 (37969)	10600 (23400)	18650 (41170)	14200 (31347)	25350 (55960)

## TECHNICAL SPECIFICATIONS OF 3D PIPE CUTTING

TOTAL WIDTH (B)	mm (inch)	5200 (205)	5700 (224)	5700 (224)	5700 (224)	6200 (244)	6700 (264)	6700 (264)	6700 (264)	7700 (303)	7700 (303)
WEIGHT (D)	mm (inch)	290 (11)	290 (11)	290 (11)	290 (11)	290 (11)	290 (11)	290 (11)	290 (11)	290 (11)	290 (11)
SPEED	m/min.	20	20	20	20	20	20	20	20	20	20
MACHINE AXIS	-	X, Y, Z, A, B, D									
WEIGHT	kg (lbs)	6600 (14570)	8000 (17660)	10400 (22958)	16750 (36976)	11100 (24503)	18600 (41060)	12000 (26490)	20000 (44150)	15600 (34437)	26750 (59051)

\* All specifications subject to change without notice.

# SMART PLASMA

• PLASMA CUTTING

**Robust... Precise...  
Economical...**

EPL Plasma Smart Series is an economical plasma cutting machine that meet your requirements by using both plasma and oxygen cutting technologies.

While saving your budget with Smart Plasma, you may also keep your productivity at the highest level with high quality parts.

- ▶ Ergonomic design
- ▶ Powerful consumables
- ▶ Lower costs
- ▶ Productivity
- ▶ Efficiency
- ▶ Oxygen cutting position



## LOW COST

Allows high precision cutting using oxygen gas only. Minimizes the cutting costs.

## HIGH PRODUCTIVITY

Brings your productivity to maximum level with its superior cutting quality in your most demanding productions thanks to its cutting speed and fast transitions.





### **EASY OPERATION**

Optimized cutting parameters are automatically adjusted and controlled in one step to achieve consistent results without operator intervention.

### **LOW OPERATING COSTS**

Offers the best performance with compromising from its speed using low amperage values. Moreover, it reduces costs per parts and increases the life cycle of consumables greatly using advanced technologies such as LongLife, COOIFLOW™ and TrueFlow™ while designing the consumables.

# SMART PLASMA

- GENERAL FEATURES

## MAX PRO 200

The MAXPRO200® LongLife® plasma cutting system is engineered for heavy-duty, high capacity automated and handheld cutting and gouging applications. The easy-to-use system operates with either air or oxygen plasma gas, and combines fast cutting speeds and quick process changes to maximize productivity. Advanced Hypertherm consumable designs – including LongLife® technology – improve cut consistency and significantly increase consumable life to lower your cost per part.



## Powermax 125

Delivering maximum power and performance for air plasma, the Powermax125® plasma system cuts thick metals fast. Able to make short work of the toughest cutting and gouging jobs, the system offers a 100% duty cycle, a 25 mm (1") mechanized pierce capability, and fast gouging metal removal. It also gives you the latest technological innovations, such as Smart Sense™ technology to automatically adjust the gas pressure. Eleven Duramax® Hyamp™ torch styles provide versatility for hand cutting, portable automation, X-Y table cutting, extended reach cutting, and robotic cutting and gouging.

## Powermax 105

The Powermax105® plasma system has the duty cycle and performance needed for tough industrial cutting and gouging jobs. Delivering superior cut capabilities on 32 mm (1-1/4") thick metals, it also offers the latest technological innovations, such as Smart Sense™ technology to automatically adjust the gas pressure. Seven Duramax™ torch styles provide versatility for hand cutting, portable automation, X-Y table cutting, and robotic cutting and gouging.





### **Powermax 85**

The premier system for cutting 25 mm (1"), the Powermax85® has the same features and options as the Powermax65®, but with more power from an output current of 85 amps. Designed to maximize uptime and productivity, the system offers the latest technological innovations, such as Smart Sense™ technology to automatically adjust the gas pressure. With a variety of Duramax™ torch styles, operators can easily select exactly the right tool for the job: hand cutting or gouging, portable automation, X-Y table, and robotic cutting or gouging.

### **Powermax 65**

The Powermax65® plasma system is a versatile machine for heavy-duty cutting and gouging in demanding environments. Designed to maximize uptime and productivity, the system offers the latest technological innovations, such as Smart Sense™ technology to automatically adjust the gas pressure. With a variety of Duramax™ torch styles, operators can easily select exactly the right tool for the job: hand cutting or gouging, portable automation, X-Y table, and robotic cutting or gouging.



### **Powermax 45 XP**

Meet the newest member of our best-selling line of Powermax® portable plasma systems. The Powermax45® XP delivers increased cut capacity – up to 16 mm (5/8") metal – as well as faster cut speeds, and automatic gas adjustment for quick, simple setup and operation. New Duramax® Lock torches support handheld and mechanized cutting of a wider range of metal thicknesses, along with precision gouging such as spot weld removal, and marking capabilities.



# SMART PLASMA

- PLASMA CUTTING

## STANDARD EQUIPMENT

- Hypertherm EDGE Connect TC CNC
  - 19" LCD industrial type touch screen
  - Hypertherm operator panel
  - Safety module input and output
  - Ethercat communication system
  - Remote connection interface
  - Phoenix interface
  - Metric and inch gauges.
- Hypertherm MaxPro200® Plasma Source
  - Hypertherm automatic-gas console
- ERMAK THC Automatic High Control System
  - Ethercat communication system
  - Safety input-output interface module
  - Nozzle Sensor
  - Collision Sensor
  - 220 mm Standard Stroke
  - Laser Pointer
- ProNest® LT CAD / CAM Software
- 3 Axis (X, Y, Z)
  - 3 pieces Mitsubishi AC servo motor and driver
  - 3 pieces planet type Neugart gear box
  - High accuracy linear rails
  - High accuracy an silent Atlanta Helis rack and pinion
  - X,Y, Z Axis Iigus brand silent cable tray
- Cutting table with pneumatic system
- Pilz safety PLC Module
- 2 Emergency buttons
- 6 Mechanical stops

## OPTIONAL EQUIPMENT

- Hypertherm PowerMax125 automatic gas console
- Hypertherm PowerMax105 automatic gas console
- Hypertherm PowerMax85 automatic gas console
- Hypertherm PowerMax65 automatic gas console
- Hypertherm PowerMax45XP automatic gas console
- Oxy-fuel cutting system
- Filter unit
- -/+45° manuel bevel cutting adaptor for oxy-fuel & Plasma
- 350 mm & 500 mm changeble stroke for oxy-fuel & Plasma
- ProNest® LTS CAD / CAM Software
- Light barrier
- Air drier
- According to the working conditions cooling fan or heater can be add to the electrical panel
- Optional electrical voltage

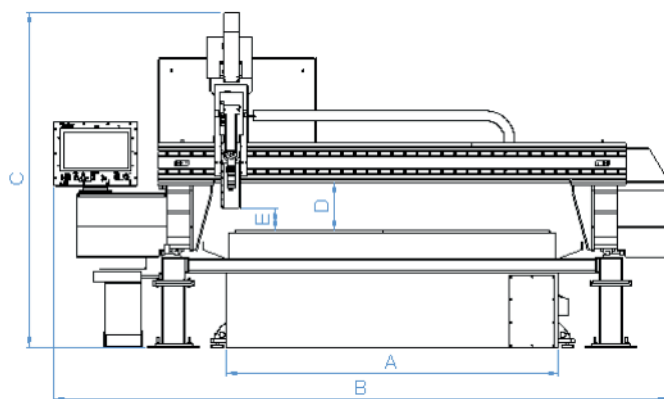

		EPL 1530 COMPACT	EPL 2040 COMPACT	EPL 2060	EPL 20120	EPL 2560	EPL 25120	EPL 3060	EPL 30120	EPL 4060	EPL 40120
CUTTING WIDTH (A)	mm (inch)	1500 (59)	2000 (79)	2000 (79)	2000 (79)	2500 (98)	2500 (98)	3000 (118)	3000 (118)	4000 (157)	4000 (157)
TOTAL WIDTH (B)	mm (inch)	3250 (128)	3750 (148)	3950 (156)	3950 (156)	4450 (175)	4450 (175)	4950 (195)	4950 (195)	6150 (242)	6150 (242)
TOTAL HEIGHT (C)	mm (inch)	2280 (90)	2280 (90)	2280 (90)	2280 (90)	2280 (90)	2280 (90)	2280 (90)	2280 (90)	2280 (90)	2280 (90)
WEIGHT (D)	mm (inch)	220 (8,6)	220 (8,6)	220 (8,6)	220 (8,6)	220 (8,6)	220 (8,6)	220 (8,6)	220 (8,6)	220 (8,6)	220 (8,6)
TORCH DISTANCE (E)	mm (inch)	100 (4)	100 (4)	100 (4)	100 (4)	100 (4)	100 (4)	100 (4)	100 (4)	100 (4)	100 (4)
CUTTING LENGTH	mm (inch)	3000 (118)	4000 (157)	6000 (236)	12000 (472)	6000 (236)	12000 (472)	6000 (236)	12000 (472)	6000 (236)	12000 (472)
TABLE HEIGHT	mm (inch)	750 (30)	750 (30)	750 (30)	750 (30)	750 (30)	750 (30)	750 (30)	750 (30)	750 (30)	750 (30)
SPEED	m/ min.	35	35	35	35	35	35	35	35	35	35
MACHINE AXIS	-	X, Y, Z									
POSITIONING ACCURACY	mm (inch)	± 0,01 DIN 28206 (± 0,0039 DIN 28206)									
POSITION REPEATABILITY ACCURACY	mm (inch)	± 0,05 DIN 28206 (± 0,0019 DIN 28206)									
PLASMA CUTTING UNIT		Hypertherm Maxpro200									
TORCH HEIGHT CONTROL		Ermak THC									
CUTTING CAPACITY	mm (inch)	1-50 (,04-1,96)	1-50 (,04-1,96)	1-50 (,04-1,96)	1-50 (,04-1,96)	1-50 (,04-1,96)	1-50 (,04-1,96)	1-50 (,04-1,96)	1-50 (,04-1,96)	1-50 (,04-1,96)	1-50 (,04-1,96)
ENERGY		400V, 50Hz, 6 Bar Air									
WEIGHT	kg (lbs)	3050 (6733)	4500 (9934)	6750 (14901)	12150 (26821)	7650 (16887)	14100 (31126)	8600 (18985)	15000 (33113)	12000 (26490)	22100 (48786)

\* All specifications subject to change without notice.

# OPTIONAL EQUIPMENT

- AVAILABLE IN ALL PLASMA SERIES

## Oxy-Fuel

Optional

Users of ProNest advanced nesting software gain an advantage when able to program for more than one cutting process. Using a single software solution to program for plasma, laser, waterjet, and oxyfuel machines can result in:

- Reduced cost of software ownership (upgrade charges, maintenance fees, etc)
- Reduced employee (programmer) training requirements
- Reduced business risk by making it easy for any employee to program any cutting machine using a single software product
- Increased flexibility allowing NC output for alternate cutting processes during a machine failure

ProNest assists companies that cut parts by providing the above benefits and delivering programming capability for virtually all plasma, laser, waterjet, oxyfuel and punch combination machines, regardless of machine brand or model.

### ProNest, ProNest LT & ProNest LTS oxy-fuel process support overview

ProNest offers complete support for the oxyfuel cutting process. ProNest also supports virtually all brands of these machines, regardless of manufacturer.

The following is an overview of the oxyfuel-specific capabilities you'll find in ProNest. Note that some machine manufacturers have their own naming convention for a number of the capabilities listed below. Please contact us with any questions you have concerning machine support not listed.



- Bridge cutting
- Bevel support
- Multi-head support with fixed and variable spacing
- Plate cropping
- Plate machine support for plate processing machines, including spindle processes
- Process parameters
  - Material type, thickness, grade and class-based process parameters including advanced kerf and feedrate commands, piercing, etc
  - Material type and thickness-based lead parameters including various lead styles (lock, edge start, etc.), angles, extensions and over-travels
  - Automatic and interactive separations for part, plate, and pierce spacing
  - User defined variables—numerous parameter configurations
- Skeleton cut-up





## Waste Gas, Dust & Fume Filtering Unit

Optional

In Ermaksan EPL plasma series, filter unit is an option. The heavy particles emerging during the cut should be taken away as much as possible. Filtering unit is designed specially for filtering the gas and particles. With this unit the dirty dust is removed, leaning a safe & clean working environment.

- Clean working ambience
- Integrated burr separator inhibiting sparks and heavy particles to Reach into the filtering unit during cutting.
- 99.9% filtration efficiency according to EN 60335/2/69.
- Synchronized automatic start and stop from CNC cutting frame as command

# SPECIAL PROJECTS

- PLASMA CUTTING

## Diverse Production Solutions

Ermaksan is continually developing to meet current demands. It can offer practical tailored solutions to suit special requests.

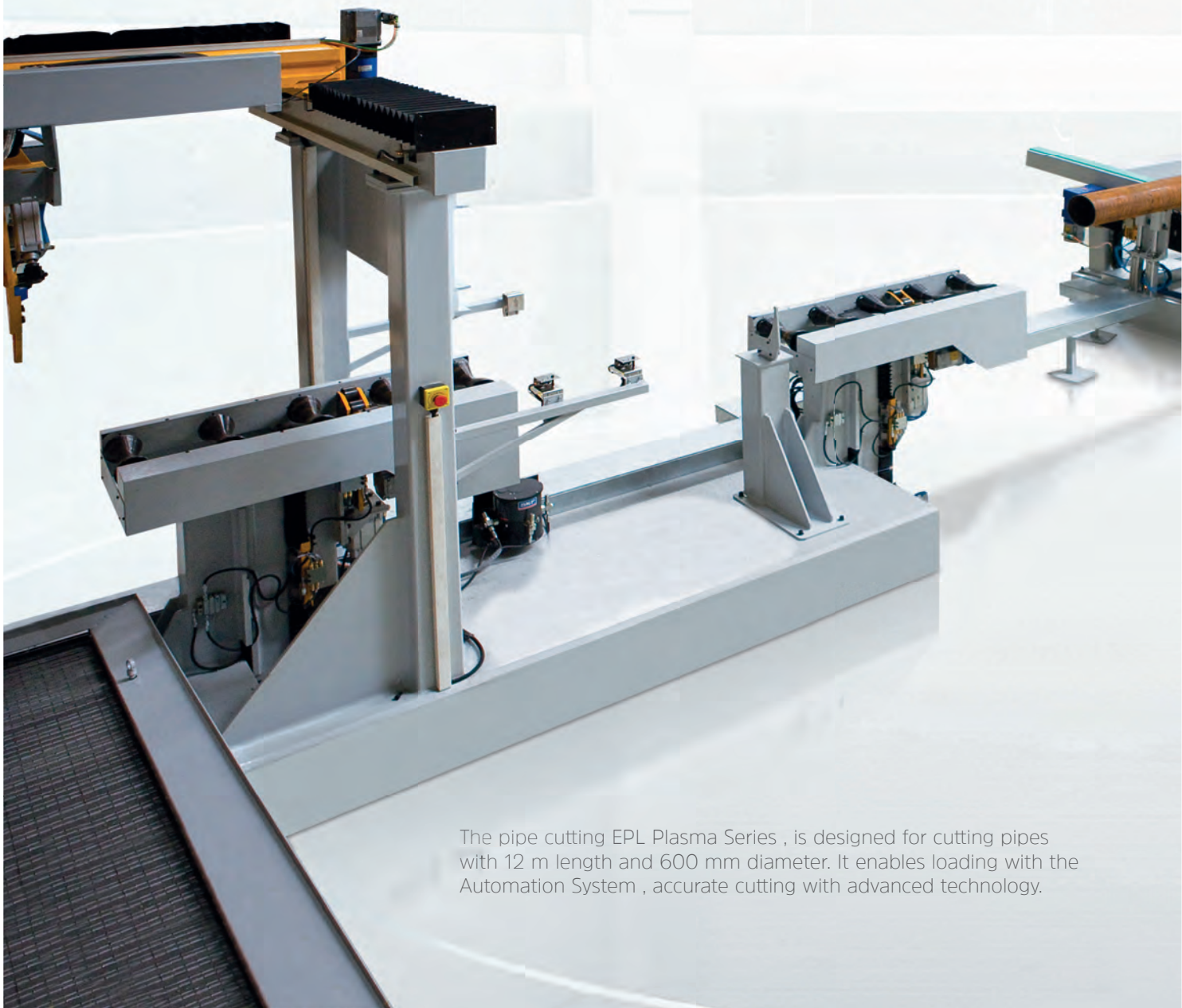

The pipe cutting EPL Plasma Series , is designed for cutting pipes with 12 m length and 600 mm diameter. It enables loading with the Automation System , accurate cutting with advanced technology.

■ EPL PLASMA

■ 12 Meter Length

■ Ø 600 mm Pipe Cutting



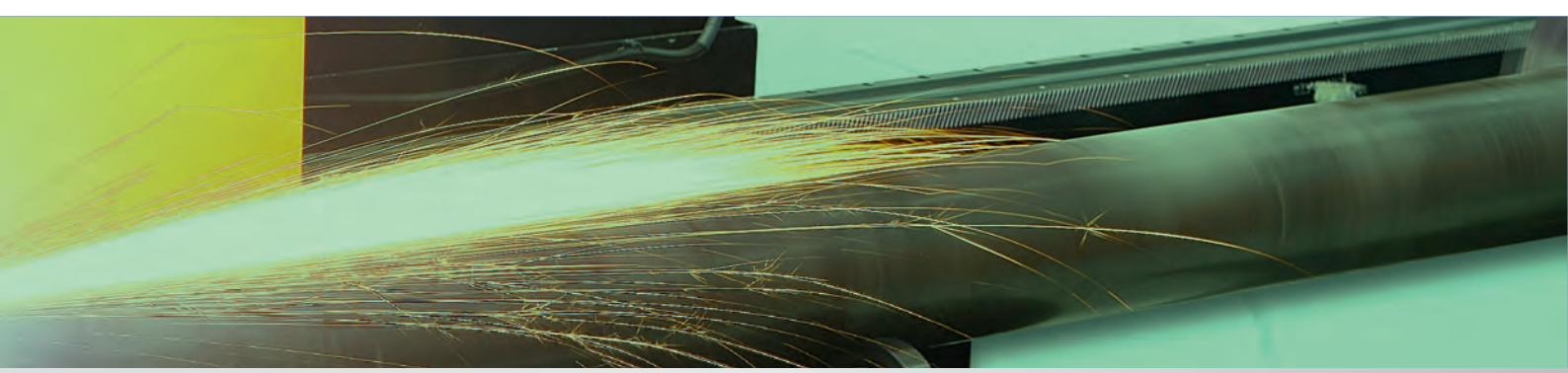

■ Full Automation Loading - Unloading

■ Iranian



# SPECIAL PROJECTS

• PLASMA CUTTING



■ EPL PLASMA

■ 3x14 Meter

■ 260 XD



■ 100 - ... - 600 Profile Cutting

■ Turkey



# SERVICE AND SPARE PARTS

- PLASMA CUTTING



## Fast, Accurate and Complete Service

Ermaksan employees always put themselves in place of their customers and act according to this idea. Thus, spare parts or technical service are provided as soon as possible. This is because the fact that the machine shall be down for a day if the the product/ service is delayed even for a day. With the awareness of this condition, spare parts and service processes are followed through a schedule in order to provide products/services as fast as possible. Thanks to Ermaksan's competent and experienced staff, you shall be able to get all the spare parts and consumables you require for your machine in a fast and accurate way independent of your location in the world.

## Remote Support Service

Ermaksan strongly encourages its customers to use original spare parts under any circumstances. This allows you to achieve high quality, long service life and maximum performance with your machine. Choose original spare parts and consumables to keep your Ermaksan machine always in the same condition as it was the first day.



## Operator Trainings with Ermaksan Academy

One of the most important activities of Ermaksan Academy is to contribute to the theoretical and practical infrastructure of the customers by providing the necessary trainings in order to increase their competencies. In order to ensure that you may use your Ermaksan machine better and more correctly, our expert engineers in Ermaksan Academy provide the necessary training for your operators and engineers and ensure that they may use the machine in the most efficient way.





## Advantages of Using Original Spare Parts

Ermaksan strongly encourages its customers to use original spare parts under any circumstances. This allows you to achieve high quality, long service life and maximum performance with your machine. Choose original spare parts and consumables to keep your Ermaksan machine always in the same condition as it was the first day.

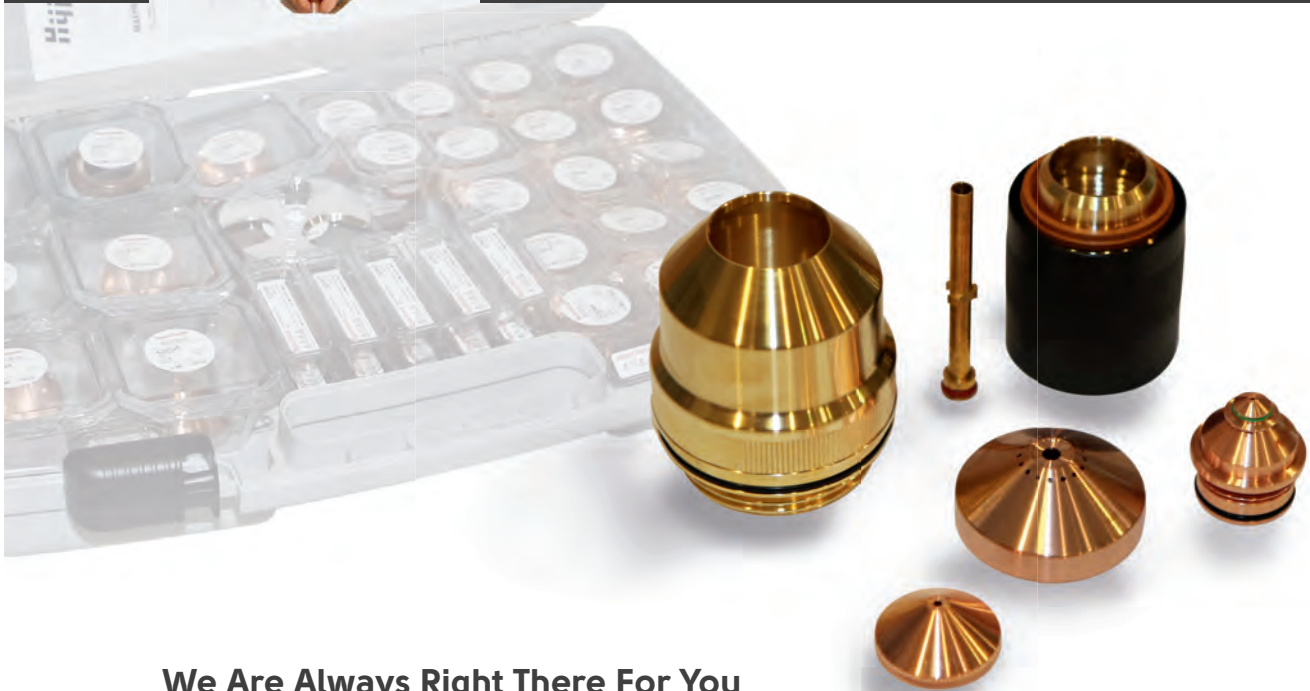

## We Are Always Right There For You

Our greatest goal is to ensure that you are satisfied with the after sales services of Ermaksan. With our qualified Ermaksan technical service engineers and after sales team, we are always right there for you whenever you need with services from periodical maintenance to repairs. We offer you the unique Ermaksan service with best quality for requirements of your spare parts and consumables besides the repair and maintenance of your machine.



**ERMAKSAN**  
INNOVATIVE TECHNOLOGIES

Organize San. Bölgesi Lacivert Cad. No:6 Nilüfer / Bursa / Turkey

T: +90 224 294 75 00 (pbx) F: +90 224 294 75 44 [ermaksan.com.tr](http://ermaksan.com.tr) | [sales@ermaksan.com.tr](mailto:sales@ermaksan.com.tr)

[ermaksanmakine](#) [ErmaksanTR](#) [ermaksanmachine](#) [ErmaksanTV](#)



1 Management Building and Main Factory

2 Laser R&D Centre

3 Laser Production Factory, Academy and P&D



**ERMAKUSA**  
INNOVATIVE TECHNOLOGIES

2860 River Road, Suite:145, 60018 Des Plaines, Illinois  
C: +1 630-512-7604 | [ermakusa.com](http://ermakusa.com) | [info@ermakusa.com](mailto:info@ermakusa.com)

**ERMAK Deutschland GmbH**  
Innovative Technologien

Ridderstrasse 52 48683 Ahaus  
T: +49 2561 - 86 00 400  
[ermakdeutschland.de](http://ermakdeutschland.de) | [info@ermakdeutschland.de](mailto:info@ermakdeutschland.de)